

Operation & Maintenance Manual

**CD-135
CD-155**

**Doc. No.: OM-02-02
Version: 4/8**

■ CAUTION:

**The Operation and Maintenance Manual
must be read completely before operating the
engine, as it contains important safety information
and information about the operation of the engine.**

◆ Note:

**The Operation and Maintenance Manual
must be included at the time of sale
of the engine / aircraft.**

◆ Note:

**Please report any service difficulties to the Technical
Support Center at Technify Motors GmbH.
See above for contact information.**

This page intentionally left blank

Table of Contents

| Chapter | Description | Page |
|----------|---|----------|
| | Table of Contents | 3 |
| | List of Figures | 11 |
| 0.1 | List of Revisions | 1 |
| 0.2 | List of applicable Chapters | 8 |
| 0.3 | Preliminary Remarks | 9 |
| 1 | Introduction | 1 |
| 1.1 | Accompanying applicable Document | 1 |
| 1.2 | Engine Identification | 2 |
| 1.3 | Copyright © | 3 |
| 1.4 | Safety Recommendations | 3 |
| 1.5 | Validity of this Manual | 3 |
| 1.6 | Abbreviations | 3 |
| 1.7 | Packaging and Transport | 4 |
| 1.8 | Storage | 4 |
| 1.9 | Scope of Supply | 5 |
| 1.10 | Qualifications of the Operating and Maintenance Personnel | 5 |
| 1.11 | Update Information Service | 5 |
| 1.12 | Service Life of this Engine | 5 |
| 1.13 | Safety Information | 6 |
| 2 | Description and Dimensions of the Engine | 1 |
| 2.1 | Engine Designation | 1 |
| 2.2 | Description and Standard Production Version | 1 |
| 2.3 | Engine Views | 2 |

| | | |
|----------|---|----------|
| 3 | Technical Data | 1 |
| 3.1 | Dimensions and Weights | 1 |
| 3.2 | Performance Data | 1 |
| 3.3 | Operational Data | 2 |
| 3.4 | Operation Limits | 2 |
| 3.5 | Fuel / Oil / Coolant | 4 |
| 3.6 | Power Curve | 8 |
| 3.7 | Low Temperature Data and Climate Classes of Diesel in Europe | 10 |
| 4 | Operation | 1 |
| 4.1 | Pre-start Inspection | 1 |
| 4.2 | Start-up | 2 |
| 4.3 | Engine Warm-up | 3 |
| 4.4 | Before Takeoff Check | 3 |
| 4.4.1 | FADEC and propeller pitch functional check | 3 |
| 4.4.2 | Engine test run for maintenance purposes (Real Time Log File (RTLTF), Internal Data Logger (IDL), Event Log (EL)) | 5 |
| 4.4.3 | FADEC-Reset (from Software 2.7 on and following) | 7 |
| 4.5 | Takeoff and Climb | 9 |
| 4.6 | During Flight | 9 |
| 4.7 | Shutting Down the Engine | 9 |

| | | |
|----------|--|----------|
| 5 | Airworthiness Limitations | 1 |
| 5.1 | Mandatory Maintenance Actions | 1 |
| 5.1.1 | Every 100 operating hours | 1 |
| 5.1.2 | Every 300 operating hours | 2 |
| 5.1.3 | Every 600 operating hours | 2 |
| 5.1.4 | Every 900 operating hours | 3 |
| 5.1.5 | Every 1200 operating hours | 3 |
| 5.1.6 | Every 1200 operating hours or every 24 months, whichever occurs first | 3 |
| 5.1.7 | Every 12 months | 3 |
| 5.1.8 | Every 60 months | 3 |
| 5.2 | Claimable Exceeds of Maintenance Actions | 4 |
| 5.2.1 | Maintenance Actions based on operating hours | 4 |
| 5.2.2 | Maintenance Actions based on time | 4 |
| 5.2.3 | Examples | 5 |
| 5.3 | Log of Revisions to Airworthiness Limitations | 6 |

| | | |
|----------|--|----------|
| 6 | Maintenance Schedules | 1 |
| 6.1 | "Pre-flight Check" | 2 |
| 6.2 | Maintenance Actions based on Operating Hours | 2 |
| 6.2.1 | After the 3rd - 6th operating hour | 3 |
| 6.2.2 | Every 100 operating hours | 4 |
| 6.2.3 | Every 200 operating hours | 5 |
| 6.2.4 | Every 300 operating hours | 5 |
| 6.2.5 | Every 600 operating hours | 6 |
| 6.2.6 | Every 900 operating hours | 7 |
| 6.2.7 | Every 1200 operating hours (only applicable for CD-135) | 7 |
| 6.2.8 | Every 1200 operating hours (only applicable for CD-155) | 8 |
| 6.2.9 | Every 1200 operating hours or every 24 months, whichever occurs first | 9 |
| 6.2.10 | Every 1500 operating hours | 9 |
| 6.2.11 | Every 1500 operating hours (only applicable for CD-135) | 9 |
| 6.2.12 | Every 1800 operating hours | 9 |
| 6.3 | Maintenance Actions based on Time | 10 |
| 6.3.1 | Every month | 10 |
| 6.3.2 | Every 12 months | 10 |
| 6.3.3 | Every 24 months | 11 |
| 6.3.4 | Every 60 months | 11 |

Operation & Maintenance Manual
CD-135 / CD-155
OM-02-02



| | |
|---|----|
| Annex 1 - Inspecting the V-Ribbed Belt | 12 |
| Annex 2 - Inspecting the Oil and Fuel System for Leakage | 13 |
| Annex 3 - Inspecting the Cooling System for Leakage | 14 |
| Annex 4 - Engine Test Run | 15 |
| Annex 5 - Exchanging the Engine Oil and Oil Filter | 16 |
| Annex 6 - Cleaning the Engine | 19 |
| Annex 7 - Checking the FADEC Sensors | 20 |
| Annex 8 - Exchanging the gearbox oil filter of the gearbox | 25 |
| Annex 9 - Checking the level of the gearbox oil of the gearbox | 32 |
| Annex 10 - FADEC Read-out | 38 |
| Annex 11 - Inspecting the High-Pressure Pump | 50 |
| Annex 12 - Replacing the Alternator | 51 |
| Annex 13 - Exchanging the gearbox oil and the gearbox oil filter at the gearbox | 52 |
| Annex 14 - Exchanging the Coolant | 65 |
| Annex 15 - Inspecting the Gearbox | 66 |
| Annex 16 - Replacing the Excitation Battery | 67 |
| Annex 17 - FADEC Software Update | 69 |
| Annex 18 - Inspecting the Fuel Feed Pump | 74 |

| | | |
|----------|--|----------|
| 7 | Emergency Procedures | 1 |
| 7.1 | Power Loss | 1 |
| 7.2 | FADEC Operation | 1 |
| 7.3 | Engine System Malfunction | 2 |
| | 7.3.1 One FADEC light flashing | 2 |
| | 7.3.2 Both FADEC lights flashing | 3 |
| | 7.3.3 Abnormal engine behavior | 3 |
| 7.4 | Restart after Engine Failure | 4 |
| 7.5 | Fire in the Engine Compartment | 4 |
| 7.6 | Air in the Fuel System (During Flight) | 5 |
| 7.7 | Oil Pressure too Low (During Flight) | 5 |
| | FOBL E8-01 Change of Hands | |
| | FOBL E8-06 Inspection of the timing chain | |
| | Engine Maintenance Checklist | |
| | - After the 3rd - 6th operating hour | |
| | Engine Maintenance Checklist | |
| | - General | |

List of Figures

- Fig. 1.1 Explanation of the chapter numbering system
- Fig. 1.1 Engine identification
- Fig. 1.2 Preservation of the engine
- Fig. 2.1 Front view of CD-135 / CD-155 (dimensions in mm)
- Fig. 2.2 Overhead view of CD-135 / CD-155 (dimensions in mm)
- Fig. 2.3 Side view of CD-135 / CD-155, LH (dimensions in mm)
- Fig. 2.4 Side view of CD-135 / CD-155, RH (dimensions in mm)
- Fig. 3.5 Power curve of CD-135 (TAE 125-02-99)
- Fig. 3.6 Power curve of CD-155 (TAE 125-02-114)
- Fig. 4.1 FADEC and propeller pitch functional check
- Fig. 6.1 Oil drain plug
- Fig. 6.2 Oil filter assy
- Fig. 6.3 Coolant temperature sensor
- Fig. 6.4 Rail pressure sensor
- Fig. 6.5 Air temperature sensor and MAP connections of the intake manifold
- Fig. 6.6 Camshaft sensor 1
- Fig. 6.7 Camshaft sensor 2
- Fig. 6.8 Crankshaft sensor 1
- Fig. 6.9 Crankshaft sensor 2
- Fig. 6.10 Gearbox temperature sensor
- Fig. 6.11 Oil pressure- and oil temperature sensor
- Fig. 6.12 Position of the oil filter cap
- Fig. 6.13 Mounting direction of the oil filter
- Fig. 6.14 Gearbox oil filter assembling
- Fig. 6.15 Lock wiring between oil drain plug and oil filter cap
- Fig. 6.16 Position of the oil filter cap
- Fig. 6.17 Removal of gearbox oil filter
- Fig. 6.18 Gearbox oil filter assembling
- Fig. 6.19 Mounting direction of the oil filter
- Fig. 6.20 Lock wiring the oil filter cap, the proportional pressure reducing valve and the gearbox housing
- Fig. 6.21 Check the oil level
- Fig. 6.22 Gearbox oil filler screw and inspection glass
- Fig. 6.23 Lock wiring the oil filler screw
- Fig. 6.24 Check the oil level
- Fig. 6.25 Gearbox oil filler screw and inspection glass
- Fig. 6.26 Lock wiring the oil filler screw
- Fig. 6.27 FADEC read-out - Start Real Time Log File
- Fig. 6.28 FADEC read-out - Enter engine specifications
- Fig. 6.29 FADEC read-out - Logging function is active
- Fig. 6.30 FADEC read-out - Stop Real Time Log File
- Fig. 6.31 FADEC read-out - Choice screen

- Fig. 6.32 FADEC read-out - Maintenance data download
- Fig. 6.33 FADEC read-out - Enter engine specifications
- Fig. 6.34 FADEC read-out - Perform engine ground run
- Fig. 6.35 FADEC read-out - Downloading
- Fig. 6.36 FADEC read-out - Choice screen
- Fig. 6.37 FADEC read-out - Where are my data files?
- Fig. 6.38 FADEC read-out - Clear warnings
- Fig. 6.39 FADEC read-out - Enter password
- Fig. 6.40 FADEC read-out - Enter password successfully
- Fig. 6.41 FADEC read-out - Hot keys
- Fig. 6.42 Overview of the gearbox inspection points
- Fig. 6.43 oil drain plug with sealing ring
- Fig. 6.44 Removal of gearbox oil filter
- Fig. 6.45 Mounting direction of the oil filter
- Fig. 6.46 Gearbox oil filter assembling
- Fig. 6.47 Lock wire between the oil drain plug and the filter cap
- Fig. 6.48 Lock wiring the oil filler screw
- Fig. 6.49 Overview of the gearbox inspection points
- Fig. 6.50 Removal of gearbox oil filter
- Fig. 6.51 Gearbox oil filter assembling
- Fig. 6.52 Mounting direction of the oil filter
- Fig. 6.53 Lock wire between oil filter cap, proportional pressure reducing valve and the gearbox housing
- Fig. 6.54 Lock wiring the oil drain screw
- Fig. 6.55 Lock wiring the oil filler screw
- Fig. 6.56 Excitation battery holder (28V)
- Fig. 6.57 Excitation battery holder (14V)
- Fig. 6.58 Start Update
- Fig. 6.59 Information displayed
- Fig. 6.60 Update progress
- Fig. 6.61 Update finished
- Fig. 6.62 Previously failed update
- Fig. 6.63 Form One
- Fig. 6.64 CRC checksums
- Fig. 6.65 FADEC Service Tool

0.1 List of Revisions

| Chapter | Issue/ Revision | Date | Approved by |
|-----------------------------|--------------------|------------|-------------|
| Issue 1 / Revision 1 | | | |
| 02-OM-00-02 | 1/1 | 27.02.2007 | Hartung |
| 02-OM-02-02 | 1/1 | 27.02.2007 | Hartung |
| 02-OM-03-02 | 1/1 | 27.02.2007 | Hartung |
| 02-OM-04-02 | 1/1 | 27.02.2007 | Hartung |
| 02-OM-05-02 | 1/1 | 27.02.2007 | Hartung |
| 02-OM-06-02 | 1/1 | 27.02.2007 | Hartung |
| Issue 1 / Revision 2 | | | |
| 02-OM-00-02 | 1/2 | 13.04.2007 | Hartung |
| 02-OM-06-02 | 1/2 | 13.04.2007 | Hartung |
| Issue 1 / Revision 3 | | | |
| 02-OM-00-02 | 1/3 | 01.02.2008 | Hartung |
| 02-OM-01-02 | 1/1 | 01.02.2008 | Hartung |
| 02-OM-03-02 | 1/2 | 01.02.2008 | Hartung |
| 02-OM-04-02 | 1/2 | 01.02.2008 | Hartung |
| 02-OM-06-02 | 1/3 | 01.02.2008 | Hartung |
| 02-OM-07-02 | 1/1 | 01.02.2008 | Hartung |
| Issue 1 / Revision 4 | | | |
| 02-OM-00-02 | 1/4 | 07.04.2008 | Hartung |
| 02-OM-06-02 | 1/4 | 07.04.2008 | Hartung |
| Issue 1 / Revision 5 | | | |
| 02-OM-00-02 | 1/5 | 18.04.2008 | Hartung |
| 02-OM-06-02 | 1/5 | 18.04.2008 | Hartung |
| Issue 1 / Revision 6 | | | |
| 02-OM-00-02 | 1/6 | 24.09.2008 | Hartung |
| 02-OM-05-02 | 1/2 | 24.09.2008 | Hartung |
| 02-OM-06-02 | 1/6 | 24.09.2008 | Hartung |

| Chapter | Issue/ Revision | Date | Approved by |
|------------------------------|--------------------|------------|-------------|
| Issue 1 / Revision 7 | | | |
| 02-OM-00-02 | 1/7 | 17.06.2009 | Hartung |
| 02-OM-01-02 | 1/2 | 17.06.2009 | Hartung |
| 02-OM-03-02 | 1/3 | 17.06.2009 | Hartung |
| 02-OM-04-02 | 1/3 | 17.06.2009 | Hartung |
| 02-OM-05-02 | 1/3 | 17.06.2009 | Hartung |
| 02-OM-06-02 | 1/7 | 17.06.2009 | Hartung |
| Issue 1 / Revision 8 | | | |
| 02-OM-00-02 | 1/8 | 12.10.2009 | Hartung |
| 02-OM-03-02 | 1/4 | 12.10.2009 | Hartung |
| Issue 1 / Revision 9 | | | |
| 02-OM-00-02 | 1/9 | 29.01.2010 | Hartung |
| 02-OM-03-02 | 1/5 | 29.01.2010 | Hartung |
| 02-OM-05-02 | 1/4 | 29.01.2010 | Hartung |
| Issue 1 / Revision 10 | | | |
| 02-OM-00-02 | 1/10 | 07.04.2010 | Hartung |
| 02-OM-05-02 | 1/5 | 07.04.2010 | Hartung |
| Issue 1 / Revision 11 | | | |
| 02-OM-00-02 | 1/11 | 21.05.2010 | Hartung |
| 02-OM-06-02 | 1/8 | 21.05.2010 | Hartung |
| Issue 2 / Revision 0 | | | |
| 02-OM-00-02 | 2/0 | 07.07.2010 | Hartung |
| 02-OM-01-02 | 2/0 | 07.07.2010 | Hartung |
| 02-OM-02-02 | 2/0 | 07.07.2010 | Hartung |
| 02-OM-03-02 | 2/0 | 07.07.2010 | Hartung |
| 02-OM-04-02 | 2/0 | 07.07.2010 | Hartung |
| 02-OM-05-02 | 2/0 | 07.07.2010 | Hartung |
| 02-OM-06-02 | 2/0 | 07.07.2010 | Hartung |

| Chapter | Issue/ Revision | Date | Approved by |
|-----------------------------|--------------------|------------|-------------|
| 02-OM-07-02 | 2/0 | 07.07.2010 | Hartung |
| Issue 2 / Revision 1 | | | |
| 02-OM-00-02 | 2/1 | 12.11.2010 | Hartung |
| 02-OM-05-02 | 2/1 | 12.11.2010 | Hartung |
| 02-OM-06-02 | 2/1 | 12.11.2010 | Hartung |
| Issue 2 / Revision 2 | | | |
| 02-OM-00-02 | 2/2 | 18.03.2011 | Hartung |
| 02-OM-04-02 | 2/1 | 18.03.2011 | Hartung |
| 02-OM-05-02 | 2/2 | 18.03.2011 | Hartung |
| 02-OM-06-02 | 2/2 | 18.03.2011 | Hartung |
| Issue 2 / Revision 3 | | | |
| 02-OM-00-02 | 2/3 | 12.04.2011 | Hartung |
| 02-OM-03-02 | 2/1 | 12.04.2011 | Hartung |
| Issue 2 / Revision 4 | | | |
| 02-OM-00-02 | 2/4 | 17.06.2011 | Hartung |
| 02-OM-03-02 | 2/2 | 17.06.2011 | Hartung |
| 02-OM-04-02 | 2/2 | 17.06.2011 | Hartung |
| 02-OM-05-02 | 2/3 | 17.06.2011 | Hartung |
| 02-OM-06-02 | 2/3 | 17.06.2011 | Hartung |
| Issue 2 / Revision 5 | | | |
| 02-OM-00-02 | 2/5 | 01.07.2011 | Hartung |
| 02-OM-03-02 | 2/3 | 01.07.2011 | Hartung |
| Issue 2 / Revision 6 | | | |
| 02-OM-00-02 | 2/6 | 07.11.2011 | Hartung |
| 02-OM-05-02 | 2/4 | 07.11.2011 | Hartung |
| 02-OM-06-02 | 2/4 | 07.11.2011 | Hartung |

| Chapter | Issue/ Revision | Date | Approved by |
|------------------------------|--------------------|------------|-------------|
| Issue 2 / Revision 7 | | | |
| 02-OM-00-02 | 2/7 | 19.12.2011 | Hartung |
| 02-OM-03-02 | 2/4 | 19.12.2011 | Hartung |
| 02-OM-05-02 | 2/5 | 19.12.2011 | Hartung |
| 02-OM-06-02 | 2/5 | 19.12.2011 | Hartung |
| Issue 2 / Revision 8 | | | |
| 02-OM-00-02 | 2/8 | 04.05.2012 | Hartung |
| 02-OM-03-02 | 2/5 | 04.05.2012 | Hartung |
| 02-OM-06-02 | 2/6 | 04.05.2012 | Hartung |
| Issue 2 / Revision 9 | | | |
| 02-OM-00-02 | 2/9 | 23.07.2012 | Hartung |
| 02-OM-03-02 | 2/6 | 23.07.2012 | Hartung |
| 02-OM-05-02 | 2/6 | 23.07.2012 | Hartung |
| 02-OM-06-02 | 2/7 | 23.07.2012 | Hartung |
| Issue 2 / Revision 10 | | | |
| 02-OM-00-02 | 2/10 | 10.07.2013 | Hartung |
| 02-OM-03-02 | 2/7 | 10.07.2013 | Hartung |
| 02-OM-05-02 | 2/7 | 10.07.2013 | Hartung |
| 02-OM-06-02 | 2/8 | 10.07.2013 | Hartung |
| 02-OM-07-02 | 2/1 | 10.07.2013 | Hartung |
| Issue 3 / Revision 0 | | | |
| 02-OM-00-02 | 3/0 | 20.09.2013 | Hartung |
| 02-OM-01-02 | 3/0 | 20.09.2013 | Hartung |
| 02-OM-02-02 | 3/0 | 20.09.2013 | Hartung |
| 02-OM-03-02 | 3/0 | 20.09.2013 | Hartung |
| 02-OM-04-02 | 3/0 | 20.09.2013 | Hartung |
| 02-OM-05-02 | 3/0 | 20.09.2013 | Hartung |
| 02-OM-06-02 | 3/0 | 20.09.2013 | Hartung |

Operation & Maintenance Manual
 CD-135 / CD-155
 OM-02-02



| Chapter | Issue/ Revision | Date | Approved by |
|-----------------------------|--------------------|------------|-------------|
| 02-OM-07-02 | 3/0 | 20.09.2013 | Hartung |
| Issue 3 / Revision 1 | | | |
| 02-OM-00-02 | 3/1 | 19.12.2013 | Hartung |
| 02-OM-03-02 | 3/1 | 19.12.2013 | Hartung |
| 02-OM-05-02 | 3/1 | 19.12.2013 | Hartung |
| 02-OM-06-02 | 3/1 | 19.12.2013 | Hartung |
| Issue 3 / Revision 2 | | | |
| 02-OM-00-02 | 3/2 | 27.01.2014 | Hartung |
| 02-OM-03-02 | 3/2 | 27.01.2014 | Hartung |
| Issue 3 / Revision 3 | | | |
| 02-OM-00-02 | 3/3 | 07.07.2014 | Hartung |
| 02-OM-01-02 | 3/1 | 07.07.2014 | Hartung |
| 02-OM-02-02 | 3/1 | 07.07.2014 | Hartung |
| 02-OM-03-02 | 3/3 | 07.07.2014 | Hartung |
| 02-OM-06-02 | 3/2 | 07.07.2014 | Hartung |
| Issue 4 / Revision 0 | | | |
| 02-OM-00-02 | 4/0 | 30.07.2014 | Hartung |
| 02-OM-01-02 | 4/0 | 30.07.2014 | Hartung |
| 02-OM-02-02 | 4/0 | 30.07.2014 | Hartung |
| 02-OM-03-02 | 4/0 | 30.07.2014 | Hartung |
| 02-OM-04-02 | 4/0 | 30.07.2014 | Hartung |
| 02-OM-05-02 | 4/0 | 30.07.2014 | Hartung |
| 02-OM-06-02 | 4/0 | 30.07.2014 | Hartung |
| 02-OM-07-02 | 4/0 | 30.07.2014 | Hartung |
| Issue 4 / Revision 1 | | | |
| 02-OM-00-02 | 4/1 | 29.08.2014 | Hartung |
| 02-OM-03-02 | 4/1 | 29.08.2014 | Hartung |
| 02-OM-05-02 | 4/1 | 29.08.2014 | Hartung |

| Chapter | Issue/ Revision | Date | Approved by |
|---|--------------------|------------|-------------|
| 02-OM-06-02 | 4/1 | 29.08.2014 | Hartung |
| Issue 4 / Revision 2 | | | |
| 02-OM-00-02 | 4/2 | 17.04.2015 | Hartung |
| 02-OM-04-02 | 4/1 | 17.04.2015 | Hartung |
| 02-OM-05-02 | 4/2 | 17.04.2015 | Hartung |
| 02-OM-06-02 | 4/2 | 17.04.2015 | Hartung |
| Engine Maintenance Checklist - After the 3rd - 6th operating hour | 4/- | 17.04.2015 | Hartung |
| Engine Maintenance Checklist - General | 4/- | 17.04.2015 | Hartung |
| Issue 4 / Revision 3 | | | |
| 02-OM-00-02 | 4/3 | 13.08.2015 | Steinberg |
| 02-OM-05-02 | 4/3 | 13.08.2015 | Steinberg |
| 02-OM-06-02 | 4/3 | 13.08.2015 | Steinberg |
| Engine Maintenance Checklist - General | 4/1 | 13.08.2015 | Steinberg |
| Issue 4 / Revision 4 | | | |
| 02-OM-00-02 | 4/4 | 02.09.2015 | Hartung |
| 02-OM-04-02 | 4/2 | 02.09.2015 | Hartung |
| 02-OM-05-02 | 4/4 | 02.09.2015 | Hartung |
| 02-OM-06-02 | 4/4 | 02.09.2015 | Hartung |
| Engine Maintenance Checklist - General | 4/2 | 02.09.2015 | Hartung |



Operation & Maintenance Manual
CD-135 / CD-155
OM-02-02



| Chapter | Issue/ Revision | Date | Approved by |
|--|--------------------|------------|-------------|
| Issue 4 / Revision 5 | | | |
| 02-OM-00-02 | 4/5 | 18.09.2015 | Hartung |
| 02-OM-06-02 | 4/5 | 18.09.2015 | Hartung |
| Engine Maintenance Checklist - General | 4/3 | 02.09.2015 | Hartung |
| Issue 4 / Revision 6 | | | |
| 02-OM-00-02 | 4/6 | 22.04.2016 | Hartung |
| 02-OM-05-02 | 4/5 | 22.04.2016 | Hartung |
| Issue 4 / Revision 7 | | | |
| 02-OM-00-02 | 4/7 | 06.06.2016 | Hartung |
| 02-OM-03-02 | 4/2 | 06.06.2016 | Hartung |
| 02-OM-05-02 | 4/6 | 06.06.2016 | Hartung |
| 02-OM-06-02 | 4/6 | 06.06.2016 | Hartung |
| Engine Maintenance Checklist - General | 4/4 | 06.06.2016 | Hartung |
| Issue 4 / Revision 8 | | | |
| 02-OM-00-02 | 4/8 | 20.07.2016 | Hartung |
| 02-OM-06-02 | 4/7 | 20.07.2016 | Hartung |
| Engine Maintenance Checklist - General | 4/5 | 20.07.2016 | Hartung |

0.2 List of applicable Chapters

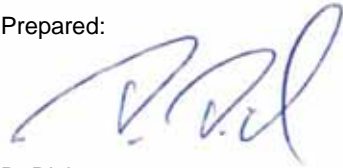
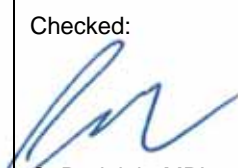
| Document No. | Document | Issue | Revision | Date |
|--------------|--|-------|----------|------------|
| 02-OM-00-02 | Lists | 4 | 8 | 20.07.2016 |
| 02-OM-01-02 | Introduction | 4 | - | 30.07.2014 |
| 02-OM-02-02 | Description and Dimensions of the Engine | 4 | - | 30.07.2014 |
| 02-OM-03-02 | Technical Data | 4 | 2 | 06.06.2016 |
| 02-OM-04-02 | Operation | 4 | 2 | 02.09.2015 |
| 02-OM-05-02 | Airworthiness Limitations | 4 | 6 | 06.06.2016 |
| 02-OM-06-02 | Maintenance Schedules | 4 | 7 | 20.07.2016 |
| 02-OM-07-02 | Emergency Procedures | 4 | - | 30.07.2014 |
| FOBL E8-01 | Change of Hands | 4 | - | 30.07.2014 |
| FOBL E8-06 | Inspection of the timing chain | 1 | - | 20.07.2016 |
| Checklist | Engine Maintenance Checklist - After the 3rd - 6th operating hour | 4 | - | 17.04.2015 |
| Checklist | Engine Maintenance Checklist - General | 4 | 5 | 20.07.2016 |

| | | |
|---|--|---|
| Prepared:  D. Dick | Checked:  C. Rudolph, MPI | Approved:  D. Hartung, MPL |
|---|--|---|

The technical information contained in this document has been approved under the authority of EASA Design Organisation Approval No. EASA.21J.010.

Technify Motors GmbH
Geschäftsführer: Carsten Rudolph, Jürgen Schwarz, Shan Tian
Amtsgericht Chemnitz HRB 28249 - USt. Ident.-Nr. DE 287721150

| | | |
|-------------|------------|---------------------------|
| Chapter: | 1 | |
| Issue: | 4 | |
| Issue date: | 30.07.2014 | |
| Page: | 8 | Revision no.: 8 |
| Content: | 10 | Revision date: 20.07.2016 |

0.3 Preliminary Remarks

1. The chapter numbering of the footer is different to the chapter numbering of the remaining manual. See Fig. 1.1.

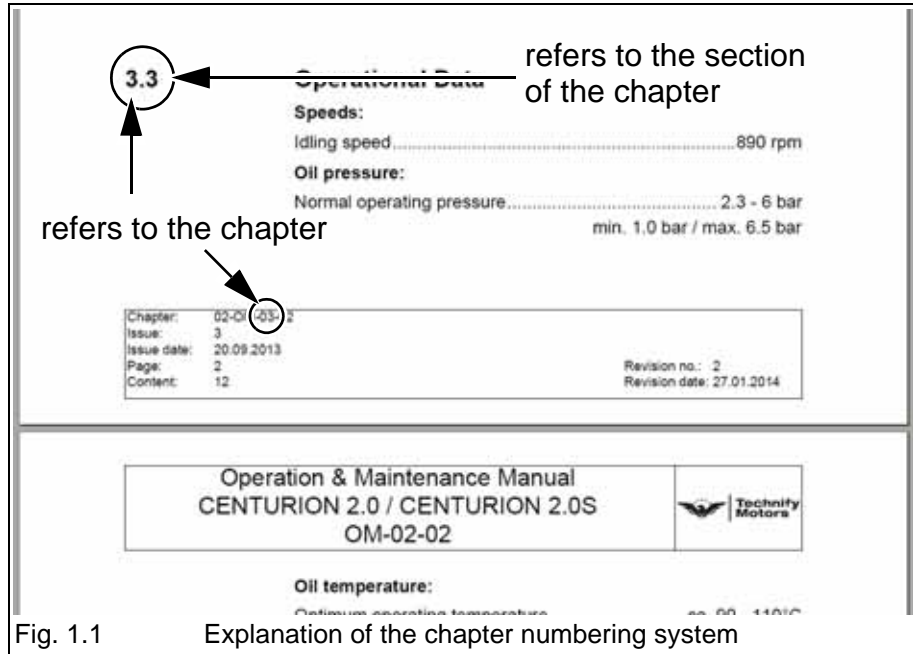



Operation & Maintenance Manual
CD-135 / CD-155
OM-02-02

This page intentionally left blank

Chapter: 1
Issue: 4
Issue date: 30.07.2014
Page: 10
Content: 10

Revision no.: 8
Revision date: 20.07.2016

1 Introduction

This Operation and Maintenance Manual contains basic information related to the proper operation of the engine in various situations and under different conditions. It also contains instructions for maintenance. The information and descriptions of components and systems in this manual were correct at the time of publication. Any amendments released through the update information service must be taken into account.

Please contact Technify Motors GmbH if you have any questions. We will be glad to provide further assistance.

Contact address:

Technify Motors GmbH
Platanenstr. 14
09356 Sankt Egidien, GERMANY
Fon: +49 37204 696-0
Fax: +49 37204 696-2912

1.1 Accompanying applicable Document

| Manual Title | Doc. No. |
|-------------------------------|-----------|
| Installation Manual | IM-02-02 |
| Repair Manual | RM-02-02 |
| Illustrated Parts Catalogue | IPC-02-02 |
| Aircraft Manufacturers Manual | --- |

◆ Note: The current version of the manuals are announced in the Service Bulletin **TM TAE 000-0004**.

1.2 Engine Identification

The serial number of the engine is provided on the data plate on the crankcase near the starter flange.

Example:

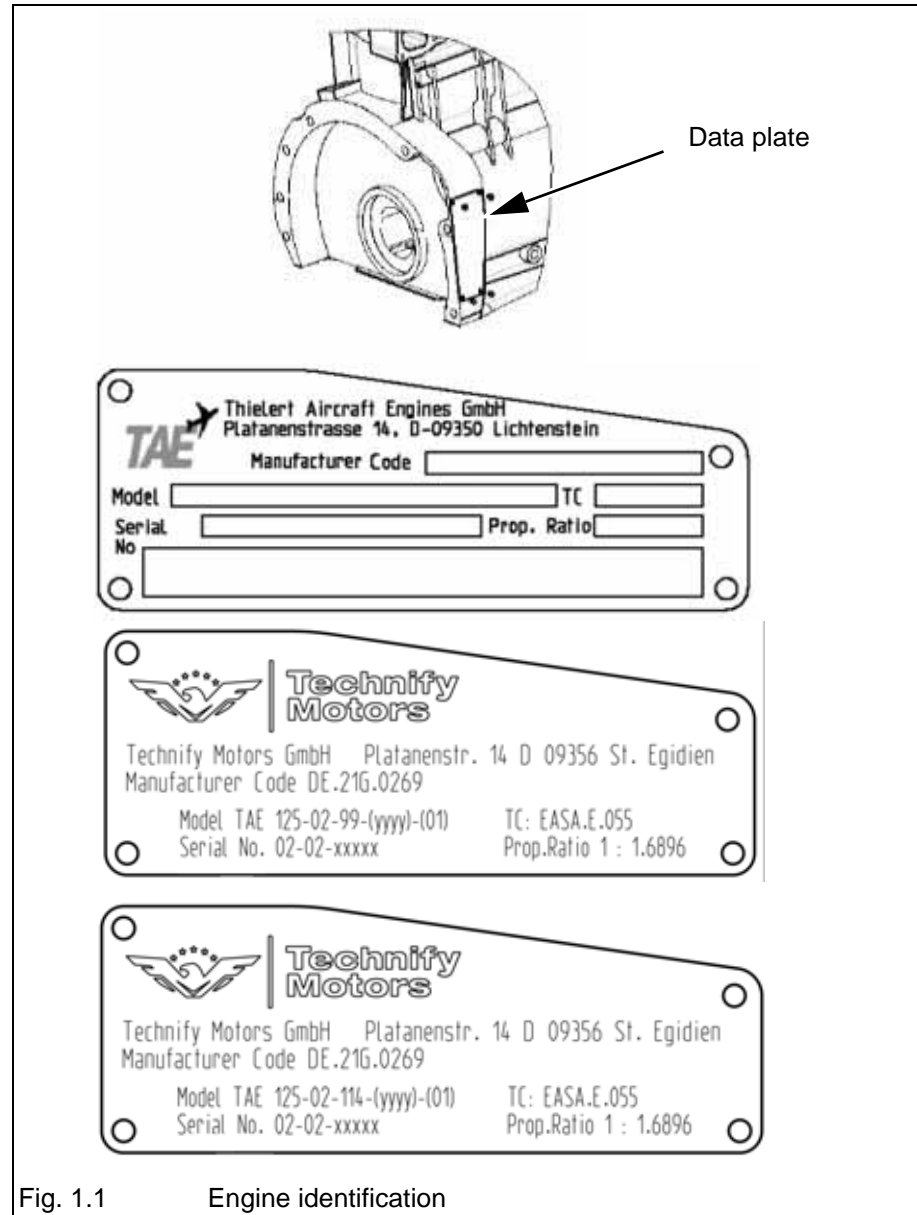

- ◆ **Note:** When making inquiries, always have the serial number of the engine ready.

- ◆ **Note:** Further information for understanding of the key for serial numbers of the engine is published in the Service Bulletin **TM TAE 000-0005**.

1.3 Copyright ©

This manual, the technical data and the information contained therein are the property of Technify Motors GmbH and may not be reproduced either in full or in part or passed on to a third party without written consent from Technify Motors GmbH.
This text must be included in any full or partial reproduction of this documentation.
Copyright © Technify Motors GmbH

1.4 Safety Recommendations

The following symbols and warning signs are used in the manual. They must be heeded strictly to prevent personal injury and material damage, to avoid impairment of the operational safety of the aircraft and to rule out any damage to the aircraft as a consequence of improper handling

| | |
|-------------------|--|
| ▲ WARNING: | Disregarding these safety rules can cause personal injury or even death. |
| ■ CAUTION: | Disregarding these special instructions and safety measures can cause damage to the engine or to other components. |
| ◆ Note: | Additional note or instructions for better understanding of an instruction. |

The indications "right", "left", "front" and "rear" are always given in relation to the flight direction. The following symbol is used:

Example of flight direction to the right: 

1.5 Validity of this Manual

Updates and modifications must be taken into account. Effective manuals are announced in the Service Bulletin **TM TAE 000-0004**.

1.6 Abbreviations

The following abbreviations are used in this manual:

- FADEC - Full Authority Digital Engine Control

1.7 Packaging and Transport

The engine has been packaged at the factory for transport as follows:

- Mounted on a support in a wooden crate
- Supplied with drying agent
- When the engine is transported by ship, it is packed seaworthy

■ **CAUTION:** Under no circumstances storage on the deck is allowed. The engine should be stored as deep as possible below deck.

The packaging should be kept for re-use in a possible future shipment.

1.8 Storage

The following must be observed during transport and subsequent storage:

- Store only in workplaces that are suitable for the purpose
- Never store outside
- Ambient temperature: -25°C to +70°C
- Rel. humidity: less than 70%
- The shipping crate must be kept in a horizontal position during storage
- The max. storage time is noted on the delivery note of the engine
- Preservation of the engine. See Fig. 1.2.

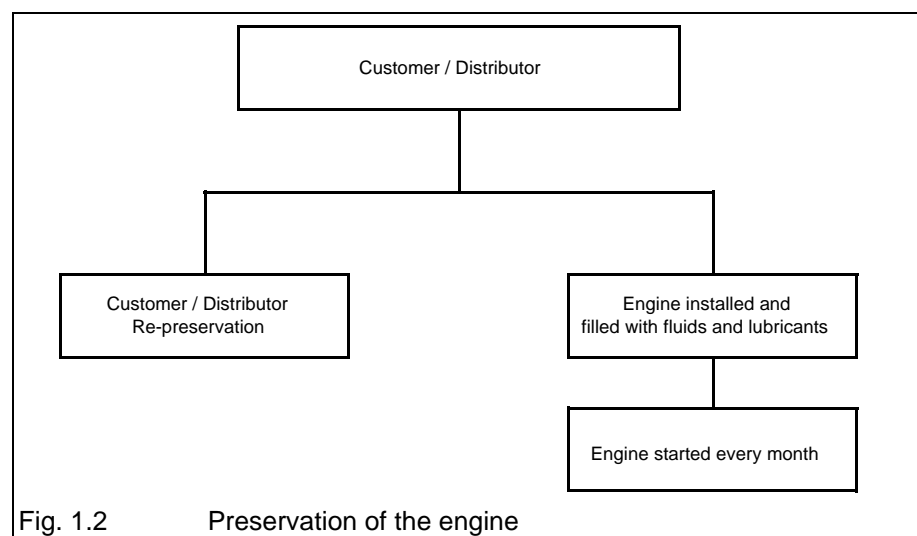

1.9 Scope of Supply

The scope of supply is specified in Chapter 2, Section 2.2, Page 1 of this Manual.

1.10 Qualifications of the Operating and Maintenance Personnel

The organizations who carry out work on the engine must be authorized by Technify Motors GmbH.

All tasks and checks described in this manual must only be performed by trained personnel who have the necessary licenses and a valid training certificate issued by Technify Motors GmbH. Further information about Technify Motors GmbH authorized organizations can be found in the Service Bulletin

TM TAE 000-0003.

All applicable national and international regulations must be observed.

1.11 Update Information Service

This manual is covered by a continuous update information service. The engine / aircraft operator is responsible for keeping up-to-date with all amendment bulletins issued by Technify Motors GmbH and integrating them into this manual.

Please inform Technify Motors GmbH if the owner of the engine / aircraft changes. This is the only way to ensure that information about any necessary / recommended changes to the engine / handbook can be passed on. A form is included for this purpose in this manual. See FOBL E8-01 - Change of Hands.

1.12 Service Life of this Engine

▲ **WARNING:**

The service life of the engine is limited.

Technify Motors GmbH therefore most strongly recommends that the engine should be replaced when it reaches the end of the operating period recommended in the relevant current version of the Service Bulletin

TM TAE 125-0001.

1.13 Safety Information

▲ **WARNING:**

Any Aircraft Engine Ground Run must be conducted in a secure area that is protected from the unauthorized movement of personnel!

Any rotating propeller is a potential safety hazard that can cause severe personal injuries or even death!

- This engine is not suitable for aerobatic use.
- This engine is not approved for rotorcraft (helicopters, gyrocopters, etc.).
- Never leave the aircraft unattended while the engine is running.
- Secure all tools before starting the engine to prevent personal injury or damage.
- When the engine is not in use, protect it and the fuel system from contamination and accidental / unauthorized manipulation.
- Never operate the engine without the specified quality and quantity of fluids.
- Engine monitoring instruments are not included in the scope of supply of the engine. Only use suitable, approved instruments.

◆ Note:

Technify Motors GmbH offers an engine display P/N 02-7730-5501-()-() suitable to monitor all necessary engine parameters.
This display is approved in accordance with JTSO-C113.

- In some areas, at some flight altitudes and under certain operating conditions, it may be necessary to protect the engine from extreme humidity, dust or sand using further special equipment. Please consult the aircraft manufacturer or distributor.
- Under extreme conditions such as low usage combined with operation in a oceanic atmosphere, or in a very dusty or sandy environment, shorter maintenance and inspection intervals are recommended for your own safety.
- The Technify Motors GmbH engine must only be taken into operation by persons who are familiar with the corresponding manuals and who have the required level of authorization.

- Only the approved equipment must be used. The use of any unapproved equipment absolves the manufacturer from any liability.
- Improper installation, the use of non-suitable lines for the fuel, cooling and oil circuits, and operation with non-approved fuels or lubricants/oils absolves the manufacturer from any liability.
- Any unauthorized modifications made to the engine or the aircraft absolve the manufacturer from liability for related damages.
- The pertinent accident prevention regulations as well as other commonly accepted safety, occupational health and air traffic legal requirements must also be observed.
- Operators must also observe any additional regulations and requirements which are applicable in their territory.

This page intentionally left blank

2 Description and Dimensions of the Engine

2.1 Engine Designation

CD-135 (TAE 125-02-99)
CD-155 (TAE 125-02-114)

2.2 Description and Standard Production Version

The Continental Diesel CD-135 / CD-155 is a liquid-cooled 4-cylinder in-line four-stroke diesel engine with DOHC (double overhead camshaft). The valves are activated by cam followers. The operation of the direct diesel-injection engine is based on the common-rail technique and is turbo charged. The engine is controlled by a FADEC system. The propeller is driven via an integrated gearbox (i=1.69) with a clutch or dual mass flywheel. The engine is equipped with an electric starter and an alternator.

Scope of Supply

The following components and assemblies are included in the scope of supply of the CD-135 / CD-155:

- Turbocharger
- Integrated propeller controlling and adjusting unit
- Alternator
- Starter
- FADEC system
- Wiring harness
- all of the actuators and sensor required for engine operation
- Vacuum pump
- Water pump
- Engine shock mounts
- Injection system
- Fuel feed pump and high-pressure fuel pump
- Oil pump
- Gearbox

2.3 Engine Views

◆ Note: The indications "right", "left", "front" and "rear" are always relative to the flight direction. The following symbol is used:

Example of flight direction right: 

Front view CD-135 / CD-155

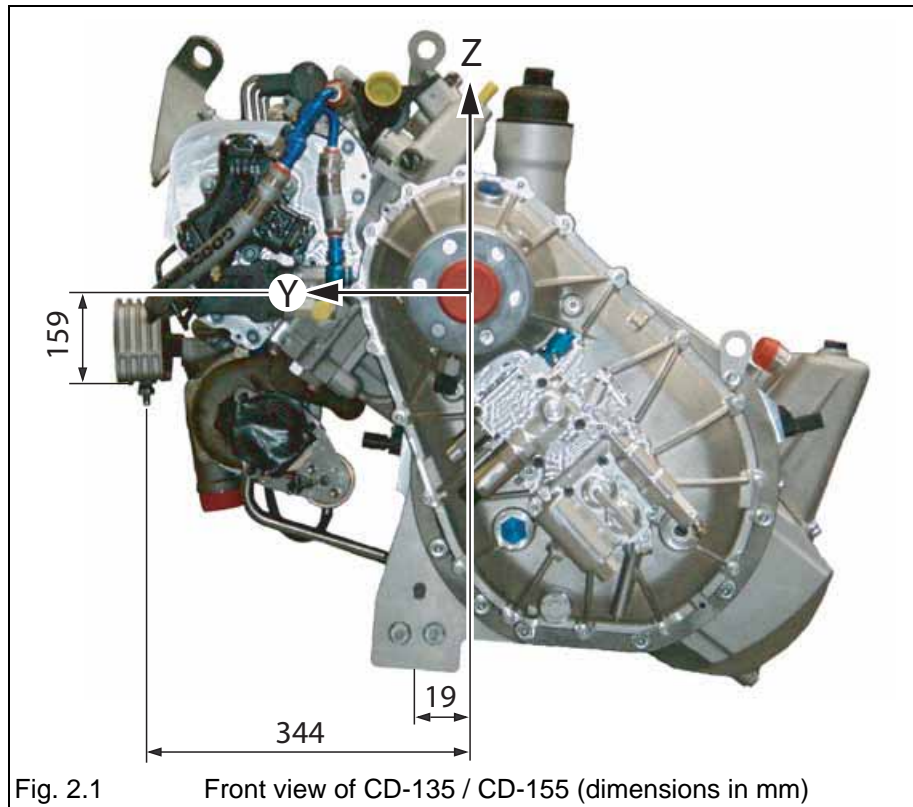

Overhead view CD-135 / CD-155

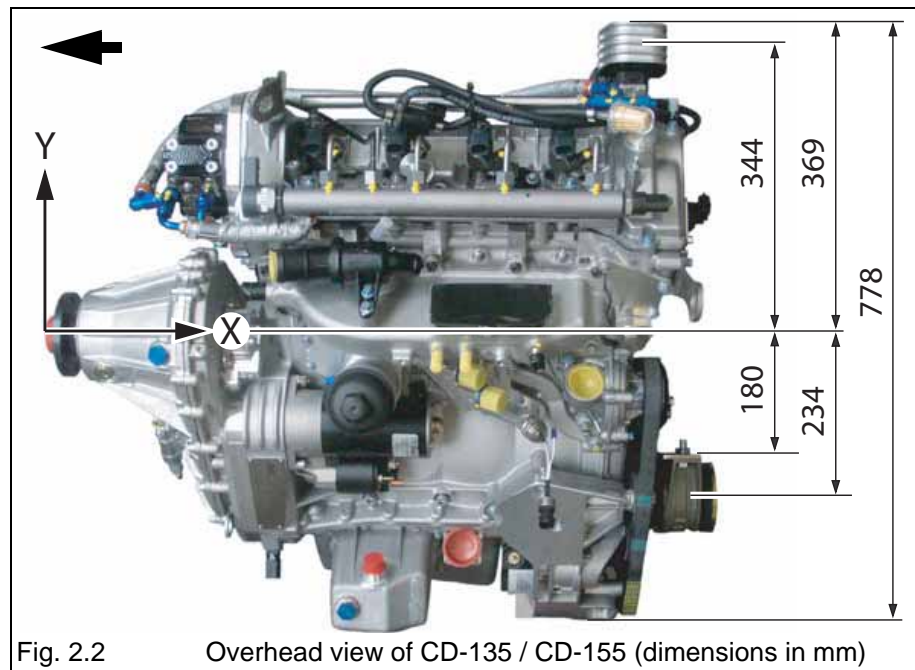

Side view CD-135 / CD-155 (flight direction to the left)

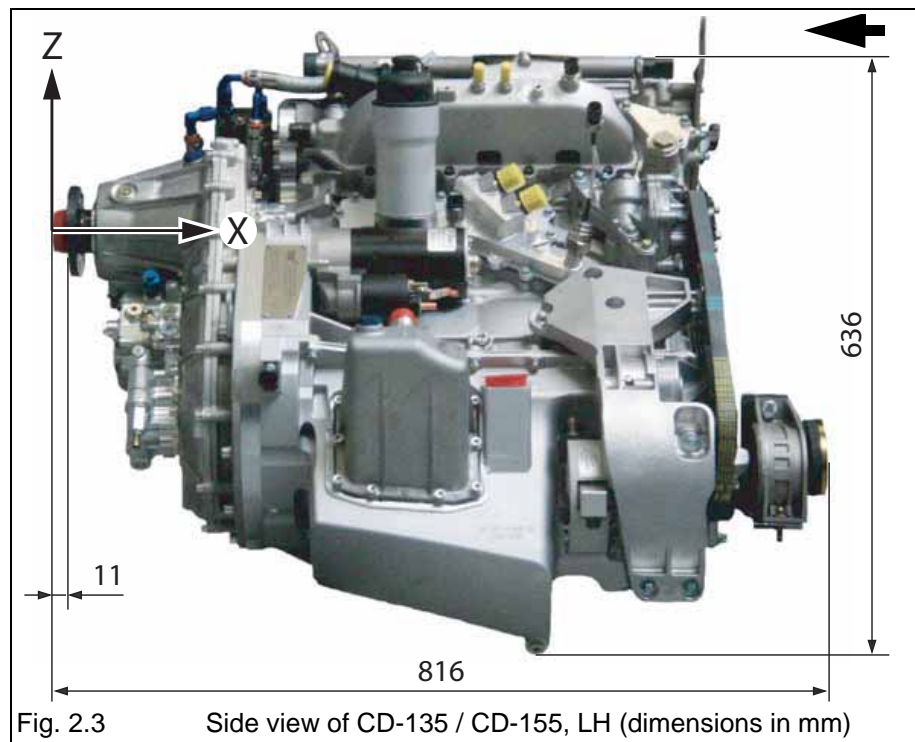

**Side view CD-135 / CD-155
(flight direction to the right)**

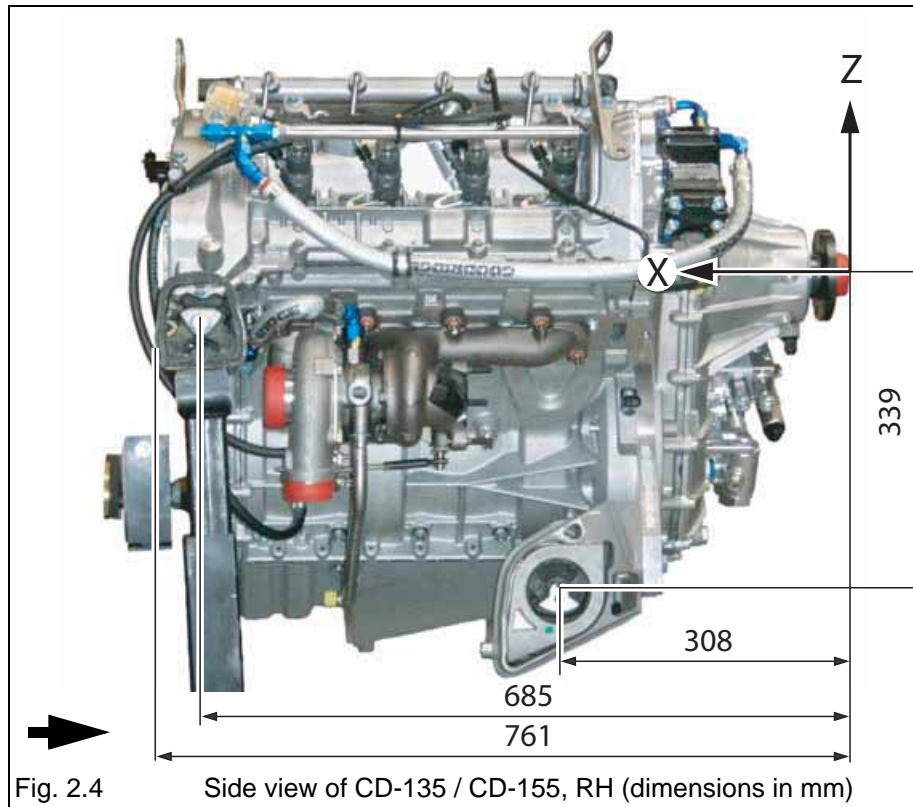

3 Technical Data

◆ Note: All speed-related data in the operation and maintenance manual refer to propeller speeds if not otherwise explicitly specified as engine speeds.

◆ Note: The performance and operational data refer to sea level at 15°C and 0% relative humidity.

3.1 Dimensions and Weights

| | |
|---|----------------------|
| Bore..... | 83.00 mm |
| Stroke..... | 92.00 mm |
| Cylinder spacing (center to center) | 90.00 mm |
| Displacement total..... | 1991 cm ³ |
| Displacement (per cylinder) | 498 cm ³ |
| Compression ratio | 18:1 |
| Firing order..... | 1-3-4-2 |

◆ Note: The cylinder numbering starts at the firewall.

| | |
|-------------------|--------|
| Weight (dry)..... | 134 kg |
|-------------------|--------|

3.2 Performance Data

CD-135 (TAE 125-02-99)

| | |
|--------------------------------|-------------------|
| Max. takeoff power..... | 99 kw at 2300 rpm |
| Max. continuous power | 99 kw at 2300 rpm |
| Recommended cruise power | 71 kw at 2010 rpm |
| Best Economy | 71 kw at 2010 rpm |

CD-155 (TAE 125-02-114)

| | |
|--------------------------------|--------------------|
| Max. takeoff power..... | 114 kw at 2300 rpm |
| Max. continuous power | 114 kw at 2300 rpm |
| Recommended cruise power | 97 kw at 2010 rpm |
| Best Economy | 97 kw at 2010 rpm |

3.3 Operational Data

Speeds:

Idling speed.....890 rpm

Oil pressure:Normal operating pressure..... 2.3 - 6 bar
min. 1.0 bar / max. 6.5 bar**Oil temperature:**Optimum operating temperatureca. 90 - 110°C
min. 50°C / max. 140°C**Coolant temperature:**Optimum operating temperatureca. 85 - 100°C
min. 60°C / max. 105°C**Gearbox temperature:**Optimum operating temperatureca. 70 - 100°C
min. -30°C / max. 120°C

3.4 Operation Limits

Min. oil temperature OT (starting) -32°C

Min. oil temperature OT (opening-up)50°C

Max. oil temperature OT140°C

Min. coolant temperature CT (starting)-32°C

Min. coolant temperature CT (opening-up)60°C

Max. coolant temperature CT.....105°C

Max. gearbox temperature GT120°C

Max. takeoff speed.....2300 rpm

Relevant to diesel operation only:

Min. fuel temperature in the fuel tank (opening up).....-5°C

◆ **Note:** The engine is capable of burning the entire range of Diesel / JET A-1, JET A, Jet Fuel No.3, JP-8, JP-8+100 and TS-1 mixture ratios.

▲ **WARNING:** If operating with diesel, the takeoff is not permitted if the temperature of the fuel in the tank is below -5°C (-10°C if Liqui Moly „Diesel Fließ-Fit“ is added at an appropriate ratio).

▲ **WARNING:** If you do not know what fuel grade is in the tank, always assume it is additive-free Diesel.

Max. continuous speed2300 rpm
Max. engine overspeed (20 sec)4220 rpm
Max. propeller overspeed (20 sec).....2500 rpm

◆ **Note:** In the case of an emergency, continued engine operation with overspeed is allowed for a maximum of 10 minutes.

Min. oil pressure1.0 bar
Min. oil pressure (at takeoff power)2.3 bar
Min. oil pressure (at cruising power)2.3 bar
Max. oil pressure6.0 bar
Max. oil pressure (cold start 20 sec.)6.5 bar
Max. oil consumption 0.1 l/h

■ **CAUTION:** At maximum continuous power setting, the CD-135 / CD-155 is suitable for operation under negative-g conditions:
of -0.2 g for 5 seconds,
of -0.3 g for 4 seconds,
of -0.4 g for 3 seconds or
of -0.5 g for 2 seconds.

3.5 Fuel / Oil / Coolant

- **CAUTION:** Use of non-approved fuel / oil / coolant can lead to dangerous malfunctions of the engine.

FuelJET A-1 (ASTM D 1655)
 JET A (ASTM D 1655)
 Jet Fuel No.3 (GB6537-2006)
 JP-8 (MIL-DTL-83133)
 JP-8+100 (MIL-DTL-83133E)
 TS-1 (GOST 10227-86)
 TS-1 (GSTU 320.00149943.011-99)

Alternative fuel Diesel (EN 590)
 SASOL GTL Diesel

-
- ▲ **WARNING:** If operating with diesel, the national appendices to standard EN 590 of the relevant country as well as the expected temperatures in the intended operating environment must be taken into account.

-
- ▲ **WARNING:** The takeoff with Diesel fuel is not permitted, if the temperature of the fuel in the tank is below -5°C (-10°C, if Liqui Moly Diesel Fliess-Fit was added in an appropriate ratio).

-
- ▲ **WARNING:** The takeoff with SASOL GTL Diesel fuel is not permitted, if the temperature of the fuel in the tank is below -5°C.

-
- ▲ **WARNING:** If the engine is being operated with a fuel mixture that contains TS-1, the maintenance interval for the high-pressure pump is shorter.
 Refer to Chapter 5, Section 5.1.2, Page 2 and Chapter 6, Section 6.2.4, Page 5 of this manual.

-
- ▲ **WARNING:** If you do not know what fuel grade is in the tank, always assume it is additive-free Diesel.

-
- ◆ **Note:** The engine is capable of burning the entire range of JET A-1, JET A, Jet Fuel No.3, JP-8, JP-8+100 and TS-1 mixture ratios.
-

Operation & Maintenance Manual
CD-135 / CD-155
OM-02-02



Fuel additives JET A: Prist Hi-Flash Anti-Icing Fuel Additive
(MIL-DTL-85470(B); ASTM D 4171)

▲ **WARNING:** Prist Hi-Flash Anti Icing Fuel Additive is only allowed for the operation with JET A.

■ **CAUTION:** If operating the engine with Prist Hi-Flash Anti-Icing Fuel Additive, the specifications of the manufacturer must be adhered to.

Fungizids Fuel additive: Fungizids Biobor JF
(MIL-S-53021A)

■ **CAUTION:** Fungizids Biobor JF Fuel Additive is allowed in operation with Diesel and JET Fuels.
Biobor JF kills hydrocarbon utilizing micro-organisms (or, HUM Bugs) which cause fuel tank contamination.
If operating the engine with Fungizids Biobor JF Fuel Additive, the specifications of the additive manufacturer and the aircraft manufacturer's instructions must be adhered to.

Engine oil AeroShell Oil Diesel Ultra
AeroShell Oil Diesel10W-40
Shell Helix Ultra 5W-30
Shell Helix Ultra 5W-40

■ **CAUTION:** Use the approved oil with exact declaration only!

Gearbox oilCENTURION Gearbox Oil N1
Shell Spirax S6 ATF ZM
Shell Spirax S6 GXME 75W-80, API GL-4
Shell Spirax S4 G 75W-90, API GL-4

■ **CAUTION:** Use the approved oil with exact declaration only!

Coolant..... Water / radiator protection in a ratio of 50:50

Radiator protection..... BASF Glysantin Protect Plus / G48

Valvoline / Zerex Glysantin G48

BASF Glysantin Alu Protect / G30

Valvoline / Zerex Glysantin G30

BASF Glysantin Protect / G05

Valvoline / Zerex Glysantin G05

Mobil Antifreeze Extra (G48)

Comma Xstream Green - Concentrate (G48)

▲ **WARNING:** No coolant loss may occur during operation! Any coolant loss must immediately be followed by a technical inspection which has to be carried out by an authorized person. Engine damage could result from coolant loss, and this could cause engine failure.

▲ **WARNING:** If the ice flocculation point of the coolant is outside the specified range, the full anti-corrosion and anti-freeze protection is possibly not guaranteed.

■ **CAUTION:** Glysantin G05, Glysantin G30 and Glysantin G48 must not be mixed with each other.

■ **CAUTION:** Operation with Glysantin G30 is only permitted without silicate pouch.

■ **CAUTION:** Operation with Glysantin G05 or Glysantin G48 is only permitted with silicate pouch.

■ **CAUTION:** Exchange between the coolants Glysantin G30 and Glysantin G05 / Glysantin G48 is not permitted without an alteration of the installation. Refer to IM-02-02.

■ **CAUTION:** Water specification:
Only use distilled water for mixing ratio.

Operation & Maintenance Manual
CD-135 / CD-155
OM-02-02



-
- ◆ Note: It is recommended to use Glysantin Protect Plus Ready-Mix and Glysantin Alu Protect Ready-Mix respectively to ensure proper coolant quality.
-
- ◆ Note: The ice flocculation point of the coolant is -38°C, if mixed 50:50. Glysantin G05, Glysantin G30 and Glysantin G48 are anti-corrosion and anti-freeze additives. The ice flocculation point must be -38°C +/-2°C. If the freezing point is outside this range the coolant has to be exchanged.
-
- ◆ Note: The aircraft coolant system might have additional requirements for the coolant.
-

3.6 Power Curve

The values refer to 0% relative humidity.

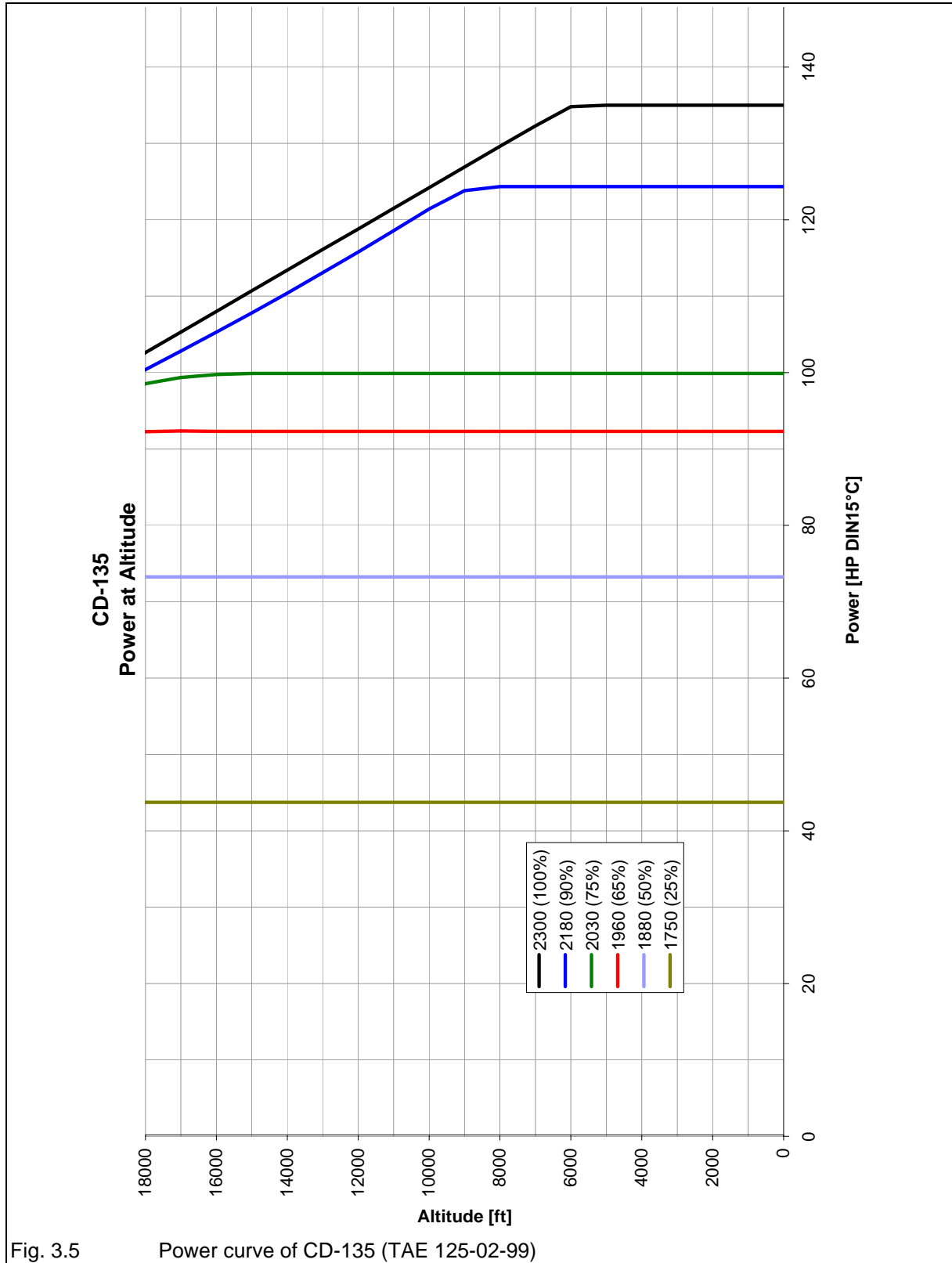

Fig. 3.5 Power curve of CD-135 (TAE 125-02-99)

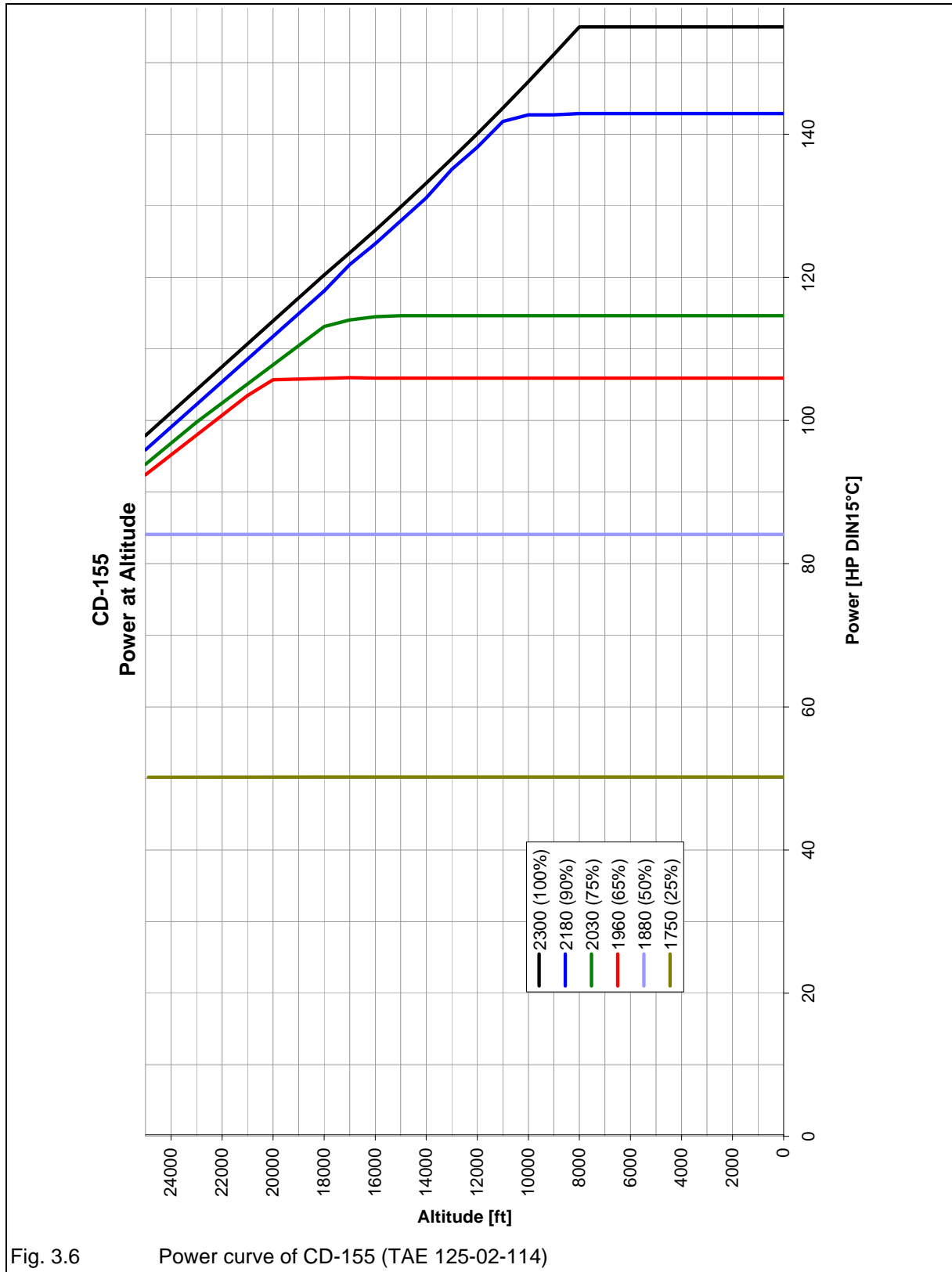

Fig. 3.6 Power curve of CD-155 (TAE 125-02-114)

3.7 Low Temperature Data and Climate Classes of Diesel in Europe

-
- ◆ Note: The officially published figures in EN 590 must be observed.
-
- ◆ Note: The minimum opening-up fuel temperature in the tank can be lowered from -5°C to -10°C if Liqui Moly „Diesel Fliess-Fit“ is added according to the application and dose specifications of Liqui Moly.
-

4 Operation

▲ **WARNING:** For operation with diesel, the aircraft must not be started if the temperature of the fuel in the tank is below -5°C (-10°C if Liqui Moly „Diesel Fliess-Fit“, No.: 5130 is added according to the manufacturer’s specifications).
If you do not know what fuel grade is in the tank, always assume it is additive-free Diesel.

▲ **WARNING:** No coolant loss may occur during operation! Any coolant loss must immediately be followed by a technical inspection by an authorized person. Coolant loss could result in engine malfunction, which can lead to engine failure!

◆ **Note:** All speed-related data in the operation and maintenance manual refer to propeller speeds unless otherwise specified explicitly as engine speeds.

4.1 Pre-start Inspection

1. Perform "Pre-flight check" (refer to Chapter 6, Section 6.1, Page 2 of this Manual)
2. Check fuel, oil and coolant quantities (refer to the aircraft manufacturer’s specifications)
3. Fuel shut-off valve - "**OPEN**"
4. Main switch for electrical system - "**ON**"
5. Check whether the load selector moves freely, check load indicator: at 0 speed, load must be shown as 0%. The load indicator is described in your Pilot’s Operating Handbook.

▲ **WARNING:** For operation with diesel, the aircraft must not be started if the temperature of the fuel in the tank is below -5°C (-10°C if Liqui Moly „Diesel Fliess-Fit“, No.: 5130 is added according to the manufacturer’s specifications).
If you do not know what fuel grade is in the tank, always assume it is additive-free Diesel.

4.2 Start-up

▲ **WARNING:** Any Aircraft Engine Ground Run must be conducted in a secure area that is protected from the unauthorized movement of personnel!
Any rotating propeller is a potential safety hazard that can cause severe personal injuries or even death!

■ **CAUTION:** If external power is used for start-up of a 12V Version of the CD-135 / CD-155, ensure that a 12V supply is used. If 24V has been used, contact Technify Motors GmbH.

◆ **Note:** The electrical fuel pump is not included in the scope of supply of the engine; instead, it is part of the aircraft installation (refer to the aircraft manual).

1. Electric fuel pump (if available) - "**ON**"
2. Load selector - "**IDLE**"
3. Inspect the hazard zone around the aircraft / propeller.
4. Switch on the Engine Master Switch, wait until the glow plug light extinguishes, then activate the starter (max. 10 seconds). Release the key or button immediately after the engine starts and leave the load selector in the idle position.

■ **CAUTION:** Do not overheat the starter. Do not operate the starter for more than 10 seconds. After operating the starter, let it cool down for 20 seconds. After six attempts to start the engine, let the starter cool down for half an hour.

5. Electrical fuel pump - "**OFF**"
6. Check the oil pressure (refer to Chapter 3, Section 3.3, Page 2 of this Manual for the values).

■ **CAUTION:** If the minimum required oil pressure of 1 bar is not indicated after 3 seconds:
switch off the engine immediately.

◆ **Note:** The glow plugs are supplied with power by a preheat relay before and during starting as well as after engine start. The FADEC is solely responsible for their activation.

4.3 Engine Warm-up

- Allow the engine to warm up for approximately 2 minutes at idle speed.
- Then increase the propeller speed to 1400 rpm until the oil temperature has reached 50°C and the coolant temperature has reached 60°C.

4.4 Before Takeoff Check

▲ **WARNING:** For operation with diesel, the aircraft must not be started if the temperature of the fuel in the tank is below -5°C (-10°C if Liqui Moly „Diesel Fliess-Fit“, No.: 5130 is added according to the manufacturer's specifications).
If you do not know what fuel grade is in the tank, always assume it is additive-free Diesel.

◆ **Note:** The engine instrumentation has to be observed during the subsequent steps.

4.4.1 FADEC and propeller pitch functional check

- a) Set the load selector to idle (both FADEC indicator lights should be off).
- b) Press and hold the FADEC test button for the duration of the entire procedure.
- c) Both FADEC A and FADEC B lights illuminate and the PROPELLER SPEED increases.
(Propeller speed target 1100-1300PropRPM)

▲ **WARNING:** If the indicator lights do not illuminate at this time, a takeoff must not be attempted with the aircraft.

- d) The system then automatically switches to the FADEC B (only the B light is on).
- e) The propeller governor is activated; the propeller speed decreases.
(Propeller speed target 800-900PropRPM)
- f) The system automatically switches to the FADEC A (only the A light is on), the propeller speed increases.
(Propeller speed target 1100-1300PropRPM)
- g) The propeller governor is activated; the propeller speed decreases.
(Propeller speed target 800-900PropRPM)

- h) The A light extinguishes, idle speed is reached; the test is completed.
- i) Release test button.

▲ **WARNING:** If there are prolonged engine misfires or the engine shuts down during the test, do not attempt a takeoff with the airplane.

▲ **WARNING:** The entire test procedure must be performed without any faults. Takeoff is not permitted with the airplane if the engine stops or the FADEC warning lights start to flash. This applies even if the engine seems to run perfectly again after completion of the test procedure.

◆ **Note:** If the test button is released before the self-test is completed, the FADEC immediately switches to normal mode.

◆ **Note:** While switching from one FADEC to another, it is normal to hear and feel a momentary surge of the engine.

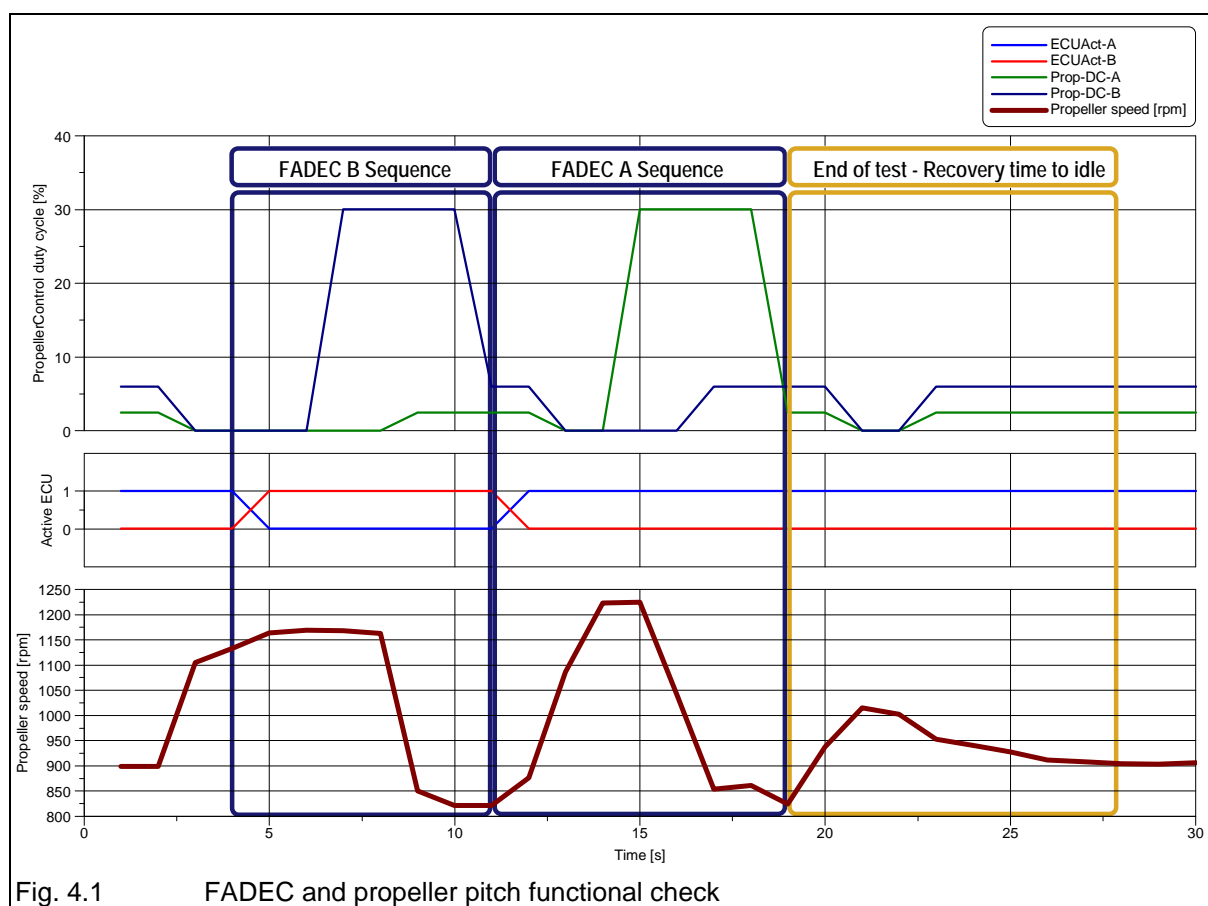

Fig. 4.1 FADEC and propeller pitch functional check

4.4.2 Engine test run for maintenance purposes (Real Time Log File (RTL), Internal Data Logger (IDL), Event Log (EL))

Make sure that the Force B switch is in the automatic position.

1. **Warm-up (in accordance with Section 4.3, Page 3 of this Chapter)**
 - Allow the engine to warm up for approximately 2 minutes at idle speed.
 - Then increase the propeller speed to 1400 rpm until the oil temperature has reached 50° C and the coolant temperature has reached 60°C.
2. **FADEC and propeller pitch functional check (in accordance with Section 4.4.1, Page 3 of this Chapter)**
3. **Check engine acceleration behavior and performance**

◆ Note: CD-135:
Propeller adjustment: 12° +0.2/-0
Turning nut by a full turn (360°) will produce a path of 1.5mm.
0.3mm are equivalent to one degree blade angle of the propeller, one degree is equivalent to a change of 100 rpm.

◆ Note: CD-155:
Propeller adjustment: 13,5° +0.2/-0
Turning nut by a full turn (360°) will produce a path of 1.5mm.
0.3mm are equivalent to one degree blade angle of the propeller, one degree is equivalent to a change of 100 rpm.

- Move the load selector quickly to the full-load position. The propeller must accelerate smoothly and steadily to the following propeller speed limits (rpm):
Single-engined 2240 rpm to 2300 rpm
Twin-engined..... 2240 rpm to 2320 rpm

The load indicator must show more than 95%.
Maintain this status for 30 seconds, then return the load selector to the idle position.
- Move the Force B switch to the FADEC B position. Move the load selector to the full-load position. The propeller must accelerate smoothly and steadily to the following propeller speed limits (rpm):
Single-engined 2240 rpm to 2300 rpm
Twin-engined..... 2240 rpm to 2320 rpm

The load indicator must show more than 95%.

Maintain this status for 30 seconds, then return the load selector to the idle position.

- Return the Force B switch to the FADEC A position.
- Using the FADEC service tool, ensure that the following parameters reach their target values (above 1800 rpm) throughout the operating range of the engine (refer to Chapter 6, Annex 10, Page 36 of this Manual):
 - Manifold Pressure (MAP): Compare MAP to MAP-Tar. Deviation must be within a tolerance of 75 mbar.
 - Propspeed (Prop RPM): Compare PropRPM to Pr-SpdTar. Deviation must be within a tolerance of +/- 50 RPM.
 - Fuel Pressure (P-Rail): Compare PRail to PRaTar. Deviation must be within a tolerance of +100/-70 bar.

▲ **WARNING:** Takeoff must only be attempted after a trouble-free engine start and engine test run.

▲ **WARNING:** Not returning the Force B switch to the FADEC A position will prevent automatic selection of the correctly functioning FADEC.

4. Check engine data

- Check the engine monitoring instrumentation. All of the engine parameters must be within the operating ranges as specified in Chapter 3, Section 3.4, Page 2 of this Manual

4.4.3 FADEC-Reset (from Software 2.7 on and following)

In case of a FADEC-warning, one or both FADEC warning lamps are flashing. If the "FADEC" test button then is pressed for at least 2 seconds, the following possibilities will occur:

Temporary failure

The active warning lamps will extinguish if it is a LOW category warning and a temporary, not steady, failure.

▲ **WARNING:** If a FADEC-warning occurred, contact your service center! Next flight is not permitted!

In case of a temporary failure the FADEC light will illuminate after the ignition has been switched off and on.

Steady failure or high category failure

The active warning lamps will illuminate steady if it is a steady failure or high category failure.

▲ **WARNING:** If a FADEC-warning occurred, contact your service center! Next flight is not permitted!

Possible reasons for activation of FADEC-Warnings are:

a) Category LOW, temporary failure (one time reset is possible)

- Engine_Speed High or Low
- FADEC switchover due to FADEC A/B RPM difference
- MAP High or Low
- MAP max. tolerated difference FADEC A/B Exceeded
- P Baro High or Low
- P Baro max. tolerated difference FADEC A/B Exceeded
- P Oil High or Low
- P Oil max. tolerated difference FADEC A/B Exceeded
- P Rail High or Low
- P Rail delta High positive or negative
- P Rail max. tolerated difference FADEC A/B Exceeded
- Propcontrol test Failed
- Sensor CAM Broken
- Sensor FADEC-Select Broken
- Sensor MAP Broken
- Sensor Mapelect Broken
- Sensor P Baro Broken
- Sensor P Fuel Broken
- Sensor P Oil Broken
- Sensor P prop Broken
- Sensor P Rail Broken
- Sensor T Air Broken
- Sensor T FADEC Broken
- Sensor Testswitch Broken
- Sensor T Fuel Broken
- Sensor T Gear Broken
- Sensor T H2O Broken
- Sensor T Oil Broken
- Sensor V Batt. Broken
- Sensor V Ref Broken
- T Air High or Low
- T Air max. tolerated difference FADEC A/B Exceeded
- T FADEC-Box max. tolerated difference FADEC A/B . Exceeded
- T FADEC_Box High or Low
- T Gear High or Low
- T Gear max. tolerated difference FADEC A/B Exceeded
- T H2O High or Low
- T H2O max. tolerated difference FADEC A/B Exceeded
- T Oil High or Low
- T Oil max. tolerated difference FADEC A/B Exceeded
- V Batt High or Low
- V Batt max. tolerated difference FADEC A/B Exceeded
- V Ref High or Low
- V Ref max. tolerated difference FADEC A/B Exceeded

b) Category HIGH, steady failure or high category failure (no reset possible by FADEC-Test Knob)

- Engine Speed max. tolerated difference ECU A/B Exceeded
- Injector Error
- Injector or InjectorPower Overcurrent
- Mapping Corrupt
- Old version Table Programmed
- Sensor Load Broken
- Sensor IV- Broken
- Sensor IV+ Broken
- Valve or ValvePower Overcurrent
- Watchdog Reset
- 50V Power Overvoltage

4.5 Takeoff and Climb

- Quickly move the load selector to the full-load position.

◆ Note: If the oil and / or water temperature approach their respective upper limits during the climb, reduce the angle of climb for a better cooling, if possible.

4.6 During Flight

- Constantly monitor whether the oil pressure, oil temperature and coolant temperature is within the operation limits (refer to Chapter 3, Section 3.4, Page 2 of this Manual for these values).
- Monitor the fuel temperature in the tank (refer to Chapter 3, Section 3.4, Page 2 of this Manual for these values).
- Monitor the FADEC warning lights.

4.7 Shutting Down the Engine

1. Load selector - "**IDLE**"
2. All electrical consumers - "**OFF**"
3. Engine Master switch - "**OFF**"
4. Main Bus switch - "**OFF**"



Operation & Maintenance Manual
CD-135 / CD-155
OM-02-02

This page intentionally left blank

Chapter: 02-OM-04-02
Issue: 4
Issue date: 30.07.2014
Page: 10
Content: 10

Revision no.: 2
Revision date: 02.09.2015

5 Airworthiness Limitations

AIRWORTHINESS LIMITATIONS APPROVAL SHEET (EASA)

This Airworthiness Limitations Section is EASA approved and mandatory. It specifies required maintenance unless an alternative program has been EASA approved.

AIRWORTHINESS LIMITATIONS APPROVAL SHEET (FAA)

The Airworthiness Limitations section is FAA approved and specifies maintenance required under Sec. 43.16 and 91.403 of Title 14 of the Code of Federal Regulations unless an alternative program has been FAA approved.

5.1 Mandatory Maintenance Actions

The following maintenance actions are mandatory due to airworthiness reasons. Any changes have to be approved by the local airworthiness authority.

5.1.1 Every 100 operating hours

- Replace fuel filter
(refer to the aircraft manufacturer's specifications)
- Replace gearbox oil filter
(refer to Chapter 6, Annex 8, Page 23 of this Manual)
- Check the presetting of the proportional pressure reducing valve (refer to RM-02-02, Chapter 72-10.05 or Chapter 72-10.16)

5.1.2 Every 300 operating hours

- Inspect gearbox (refer to Chapter 6, Annex 15, Page 63 of this Manual)
- Replace clutch, if clutch assy 05-7211-K006001 or 05-7211-K006002 is installed (refer to RM-02-02, Chapter 72-10.02)
- Inspect fuel feed pump, except 05-7312-K0073xx, 05-7312-K0133xx (refer to Chapter 6, Annex 18, Page 71 of this Manual)
- Replace high-pressure pump (refer to Chapter 6, Annex 11, Page 48 of this Manual)

◆ **Note:** Replacement of the high-pressure pump at every 300 operating hours is only applicable if TS-1 jet fuel is being used.

5.1.3 Every 600 operating hours

- Replace alternator 14V (refer to Chapter 6, Annex 12, Page 49 of this Manual)
- Replace alternator 28V (refer to Chapter 6, Annex 12, Page 49 of this Manual)
- Replace high-pressure pump (refer to Chapter 6, Annex 11, Page 48 of this Manual)

■ **CAUTION:** If TS-1 jet fuel is being used, the high-pressure pump **MUST** be replaced every 300 operating hours.

- Inspect fuel feed pump 05-7312-K0073xx, 05-7312-K0133xx (refer to Chapter 6, Annex 18, Page 71 of this Manual)
- Replace rail pressure control valve (refer to RM-02-02, Chapter 73-10.07)
- Inspect dual mass flywheel (refer to RM-02-02, Chapter 05-20.02)
- Inspect gearbox (refer to Chapter 6, Annex 15, Page 63 of this Manual)

■ **CAUTION:** The 600 hrs gearbox inspection interval is only valid in combination with the dual mass flywheel and the use of gearbox oil Shell Spirax S6 ATF ZM or CENTURION Gearbox Oil N1. In all other cases, the interval remains at 300 hrs. Expect gearboxes listed under Chapter 5.1.5.

5.1.4 Every 900 operating hours

- Replace friction disk, if clutch assy 05-7211-K0094xx is installed (refer to RM-02-02, Chapter 72-10.14)

5.1.5 Every 1200 operating hours

- Replace v-ribbed belt (refer to RM-02-02, Chapter 72-20.01)
- Replace proportional pressure reducing valve (part of the gearbox)
- Inspect gearbox (refer to Chapter 6, Annex 15, Page 63 of this Manual)

■ CAUTION: The 1200 hrs gearbox inspection interval is only valid for P/N:
05-7212-K0435 02 CD-135 14V
05-7212-K0436 02 CD-135 28V
05-7212-K0437 02 CD-155 14V
05-7212-K0438 02 CD-155 28V
05-7212-K0439 02 CD-135 28V DA42
05-7212-K0440 02 CD-155 28V DA42
05-7212-K0413 03 CD-135 14V
05-7212-K0414 03 CD-135 28V
05-7212-K0415 03 CD-155 14V
05-7212-K0416 03 CD-155 28V
05-7212-K0417 03 CD-135 28V DA42
05-7212-K0418 03 CD-155 28V DA42
or later approved revisions, in combination with the dual mass flywheel and the use of gearbox oil Shell Spirax S6 ATF ZM or CENTURION Gearbox Oil N1.
In all other cases, the interval remains at 300 or 600 hrs.

5.1.6 Every 1200 operating hours or every 24 months, whichever occurs first

- Exchange coolant (refer to aircraft manufacturer's specifications)

5.1.7 Every 12 months

- Replace excitation battery of the alternator (refer to Chapter 6, Annex 16, Page 64 of this Manual)

5.1.8 Every 60 months

- Replace all fuel, oil and cooling lines

5.2 Claimable Exceeds of Maintenance Actions

■ CAUTION: Exceedings must not be cumulated!

5.2.1 Maintenance Actions based on operating hours

| Operating Hours Intervals | Claimable Exceeding of the Basic Interval |
|---|---|
| up to and including 100 operating hours | ± 10 % |
| between 101 and 1000 operating hours | ± 5 % |
| more than 1000 operating hours | ± 50 operating hours |

5.2.2 Maintenance Actions based on time

| Time Intervals | Claimable Exceeding of the Basic Interval |
|------------------------------|---|
| up to and including 2 months | ± 5 days |
| between 2 months and 1 year | ±15 days |
| more than 1 year | ± 30 days |

5.2.3

Examples

a) Limited intervals based on operating hours

- Maintenance action due on:
300 operating hours (100 hours check)
- Maintenance action must be performed between:
290 and 310 operating hours

The maintenance action is performed at the latest at 310 operating hours. Assume the basic interval for the next 100 hours check, i.e.:

400 operating hours (100 hours check) must be performed between 390 and 410 operating hours.

b) Limited intervals based on time

- Maintenance action due on:
01.Nov.2004 (12 months check)
- Maintenance action must be performed between:
15.Oct.2004 and 15.Nov.2004

The maintenance action is performed at the latest at 15. Nov. 2004. Assume the basic interval for the next maintenance action with the same interval, i.e.:

01. Nov. 2005 (12 months check) must be performed between

15. Oct. 2005 and 15. Nov. 2005.

5.3 Log of Revisions to Airworthiness Limitations

| Issue / Revision No. | Description of Revision |
|----------------------|---|
| 1 / 1 | Revision of the Inspection Time Intervals of the Airworthiness Limitation Section |
| 1 / 2 | Implementation of rail pressure control valve inspection (every 600 operating hours) Increase of fuel feed pump 05-7310-K007301 inspection (every 600 operating hours) Increase of coolant exchange (every 1200 operating hours) Increase of v-ribbed belt replacement (every 1200 operation hours) |
| 1 / 3 | Revision of the reference to the chapter in the Repair Manual for presetting of the proportional pressure reducing valve (at every 100 operating hours) Implementation of high-pressure pump inspection (every 300 operating hours) in case of TS-1 jet fuel is being used (for clarification of the situation, one Note and one Caution were added as well) |
| 1 / 4 | Editorial changes |
| 1 / 5 | Increase of fuel feed pump 05-7310-K007301 inspection (every 1200 operating hours) Implementation of friction disk replacement of the new clutch design (every 300 operating hours) |
| 2 / 0 | Editorial changes |
| 2 / 1 | Editorial changes |
| 2 / 2 | Editorial changes Adaptation of clutch assy P/N |
| 2 / 3 | Implementation of FAA approval statement |
| 2 / 4 | Implementation of proportional pressure reducing valve 28V replacement (every 600 hrs) Editorial changes |
| 2 / 5 | Increase of friction disk replacement (every 600 hrs) |
| 2 / 6 | Implementation of a new fuel feed pump 05-7312-K0133xx |
| 2 / 7 | Implementation of a dual mass flywheel and its inspection (every 600 hrs) |

| Issue / Revision No. | Description of Revision |
|----------------------|--|
| 3 / 0 | Increase of gearbox inspection (every 600 hrs). Caution must be observed |
| 3 / 1 | Editorial changes Amendment of caution. Additional gearbox oil added. |
| 4 / 0 | Editorial changes Change of Header |
| 4 / 1 | Implementation of a new fuel feed pump 05-7312-K0177xx |
| 4 / 2 | Increase of proportional pressure reducing valve replacement (1200 hrs.) |
| 4 / 3 | Update of FAA approval statement Increase of friction disc replacement (every 900 hrs.) |
| 4 / 4 | Decrease of fuel feed pump inspection 05-7312-K0073xx, 05-7312-K0133xx (every 600 hrs.), 05-7312-K0177xx deleted |
| 4 / 5 | Delete of Note for US-registered aircrafts. |
| 4 / 6 | Increase of gearbox inspection (every 1200 hrs) for specific gearboxes Caution must be observed |

Airworthiness Limitations

This page intentionally left blank

6 Maintenance Schedules

The specified maintenance schedule applies to all aircraft regardless of type and ensures the reliability of the engine. The maintenance work on Technify Motors GmbH engines must be carried out after specific time intervals or upon reaching a specific number of operating hours. It is recommended to perform a "Pre-flight inspection" before each flight.

Components that are not part of the scope of supply of the engine must be maintained and checked in accordance with the aircraft manufacturer's specifications (refer also to the aircraft manual).

▲ **WARNING:** The entire engine has a service life ("time between replacement") recommended by the manufacturer; refer to Service Bulletin **TM TAE 125-0001**.

▲ **WARNING:** It is strongly recommended that the maintenance intervals specified by the manufacturer will be observed. Non-compliance with the maintenance schedule can lead, among other things, to a forfeiture of any claims of warranty.

◆ Note: For this engine there is a lifetime extension program for service life (time between replacement). Up-to-date information about the recommended service life is published in Service Bulletin **TM TAE 125-0001**.

◆ Note: Further information concerning service partners and servicing or parts to be replaced is published in Service Bulletin **TM TAE 000-0003**.

◆ Note: Technify Motors GmbH should be informed immediately in the event of any engine malfunction and diagnosis.

6.1 "Pre-flight Check"

- All switches - "**OFF**"
- Check the engine oil level (refer to IM-02-02, Chapter 4 for filling quantities)

■ **CAUTION:** When checking the engine oil level screw in the dipstick completely!

■ **CAUTION:** Checking the oil level at operating start temperature but not until 5 minutes after shut down the engine.

◆ **Note:** The engine oil level can vary, because of the back flow of engine oil. After 5 minutes 80% of the engine oil returned into the oil pan, after 15 minutes 90% and after 30 minutes 100%.

- Check gearbox oil level (refer to Annex 9, Page 32 of this Chapter)
- Check each of the fuel tanks for water and debris
- Electrical Master switch - "**ON**"
- Engine Master switch - "**ON**"
- Check coolant level by observing control lamp

■ **CAUTION:** The lamp "Water level" must be OFF.

- Start the engine according to Chapter 4, Section 4.2, Page 2 of this Manual and conduct a FADEC test run

6.2 Maintenance Actions based on Operating Hours

▲ **WARNING:** Under extreme conditions such as low usage combined with operation in a salt-water environment, or in a very dusty or sandy environment shorter maintenance and inspection intervals are recommended for your own safety.

◆ **Note:** Chapter 1, Section 1.10, Page 5 of this Manual must be observed.

6.2.1

After the 3rd - 6th operating hour

- Check the oil system for leakage (refer to Annex 2, Page 13 of this Chapter)
- Check the fuel system for leakage (refer to Annex 2, Page 13 of this Chapter)
- Check the cooling system for leakage (refer to Annex 3, Page 14 of this Chapter)
- Visual inspection of the air filter
- Visual inspection of hoses and fuel pipes (refer to RM-02-02, Chapter 05-20.03)
- Visual inspection of the FADEC sensors (refer to Annex 7, Page 20 of this Chapter)
- Visual inspection of the exhaust system
- Visual inspection of the v-ribbed belt (refer to Annex 1, Page 12 of this Chapter)
- Perform an engine test run according to Chapter 4, Section 4.4.2, Page 5 of this Manual, read out the FADEC. E-mail both the Real Time Log Files and Event Log Files to Technify Motors GmbH (refer to Annex 10, Page 38 of this Chapter)
- Exchange the gearbox oil filter (refer to Annex 8, Page 25 of this Chapter);
The used gearbox oil filter should be labeled, stored in a clean container and made available to Technify Motors GmbH on request for the complete engine life time. The sample will be required for a later long-run analysis. The label must show the aircraft serial number, registration number, engine serial number, operation time and date.
- Check the presetting of the proportional pressure reducing valve (refer to RM-02-02, Chapter 72-10.05 or Chapter 72-10.16)

6.2.2

Every 100 operating hours

- Visual inspection of the air filter
- Visual inspection of the cooling system
- Visual inspection of the oil system
(refer to Annex 2, Page 13 of this Chapter)
- Visual inspection of the fuel system
(refer to Annex 2, Page 13 of this Chapter)
- Visual inspection of the FADEC sensors
(refer to Annex 7, Page 20 of this Chapter)
- Visual inspection of the exhaust system
- Visual inspection of the v-ribbed belt
(refer to Annex 1, Page 12 of this Chapter)
- Visual inspection of the clamp on the turbocharger
- Visual inspection of all fuel, oil, cooling system lines and hoses for chafe marks
(refer to RM-02-02 Chapter 05-20.03)
- Visual inspection of the engine mount for chafe marks
- Check the airframe fuel pump
(refer to the aircraft manufacturer's specifications)
- Test the cooling system under pressure at 2.0 bar
Duration: 2 minutes. Max. 2.0 bar must not be exceeded!
Afterwards check for leakage
(refer to the aircraft manufacturer's specifications).
- Perform an engine test run according to Chapter 4, Section 4.4.2, Page 5 of this Manual and read out the FADEC.
E-mail both the Real Time Log Files and Event Log Files to Technify Motors GmbH
(refer to Annex 10, Page 38 of this Chapter).
- Exchange the engine oil and the oil filter (refer to Annex 5, Page 16 of this Chapter);
A sample of the oil and the used oil filter should be labeled, stored in a clean container and made available to Technify Motors GmbH on request for the complete engine life time. The sample will be required for a later long-run analysis. The label must show the aircraft serial number, registration number, engine serial number, operation time and date. Quantity of oil to be taken for sample: 100ml
- Check the mixture ratio of the coolant
- Replace the fuel filter (refer to the aircraft manufacturer's specifications)

- Exchange gearbox oil and the gearbox oil filter (refer to Annex 13, Page 52 of this Chapter);
A sample of the oil and the used gearbox oil filter should be labeled, stored in a clean container and made available to Technify Motors GmbH on request for the complete engine life time. The sample will be required for later long-run analysis. The label must show the aircraft serial number, registration number, engine serial number, operation time and date.
Quantity of oil to be taken for sample: 100ml
- Check the presetting of the proportional pressure reducing valve (refer to RM-02-02, Chapter 72-10.05 or Chapter 72-10.16)

6.2.3 Every 200 operating hours

- Carry out all steps described in Section 6.2.2, Page 4 of this Chapter
- Replace air filter

◆ Note: When replacing the air filter check carefully that no foreign objects are in it.

6.2.4 Every 300 operating hours

- Carry out all steps described in Section 6.2.2, Page 4 of this Chapter
- Replace clutch, if clutch assy 05-7211-K006001 or 05-7211-K006002 is installed (refer to RM-02-02, Chapter 72-10.02)
- Inspect gearbox (refer to Annex 15, Page 66 of this Chapter)
- Inspect fuel feed pump, except 05-7312-K0073xx, 05-7312-K0133xx (refer to Chapter 6, Annex 18, Page 74 of this Manual)
- Replace high-pressure pump (refer to Annex 11, Page 50 of this Chapter)

◆ Note: Replacement of the high-pressure pump at every 300 operating hours is only applicable if TS-1 jet fuel is being used.

6.2.5**Every 600 operating hours**

- Carry out all steps described in Section 6.2.3, Page 5 of this Chapter
- Carry out all steps described in Section 6.2.4, Page 5 of this Chapter
- Replace alternator 14V (refer to Annex 12, Page 51 of this Chapter)
- Replace alternator 28V (refer to Annex 12, Page 51 of this Chapter)
- Replace high-pressure pump (refer to Annex 11, Page 50 of this Chapter)

■ **CAUTION:** If TS-1 jet fuel is being used, the high-pressure pump **MUST** be replaced every 300 operating hours.

- Inspect fuel feed pump, 05-7312-K0073xx, 05-7312-K0133xx (refer to Annex 18, Page 74 of this Chapter)
- Replace rail pressure control valve (refer to RM-02-02, Chapter 73-10.07)
- Inspect dual mass flywheel (refer to RM-02-02, Chapter 05-20.02)
- Inspect AltReg loom (refer to RM-02-02, Chapter 05-20.01)
- Inspect gearbox (refer to Annex 15, Page 66 of this Chapter)

■ **CAUTION:** The 600 hrs gearbox inspection interval is only valid in combination with the dual mass flywheel and with the use of gearbox oil Shell Spirax S6 ATF ZM or CENTURION Gearbox Oil N1. In all other cases, the interval remains at 300 hrs. Expect gearboxes listed under Chapter 6.2.7 / Chapter 6.2.8.

6.2.6 Every 900 operating hours

- Carry out all steps described in Section 6.2.4, Page 5 of this Chapter
- Replace timing chain
ONLY applicable for engines Version 01
(refer to RM-02-02, Chapter 72-30.02)
- Replace friction disk, if clutch assy 05-7211-K0094xx is installed (refer to RM-02-02, Chapter 72-10.14)

**6.2.7 Every 1200 operating hours
(only applicable for CD-135)**

- Carry out all steps described in Section 6.2.5, Page 6 of this Chapter
- Replace v-ribbed belt (refer to RM-02-02, Chapter 72-20.01)
- Exchange coolant
(refer to the aircraft manufacturer's specifications)
- Replace coolant hose 05-7523-K0048xx (only DA42 installations)
- Visual inspection of the gasket of the turbocharger oil return line, replace if necessary.
- Replace proportional pressure reducing valve (part of the gearbox)
- Inspect gearbox (refer to Chapter 6, Annex 15, Page 63 of this Manual)

■ **CAUTION:** The 1200 hrs gearbox inspection interval is only valid for P/N:
 05-7212-K0435 02 CD-135 14V
 05-7212-K0436 02 CD-135 28V
 05-7212-K0439 02 CD-135 28V DA42
 05-7212-K0413 03 CD-135 14V
 05-7212-K0414 03 CD-135 28V
 05-7212-K0417 03 CD-135 28V DA42
 or later approved revisions, in combination with the dual mass flywheel and the use of gearbox oil Shell Spirax S6 ATF ZM or CENTURION Gearbox Oil N1.
 In all other cases, the interval remains at 300 or 600 hrs.

- Inspect timing chain
ONLY applicable for engines Version 02
(refer to RM-02-02, Chapter 05-20.04)

6.2.8**Every 1200 operating hours
(only applicable for CD-155)**

- Carry out all steps described in Section Section 6.2.5, Page 6 of this Chapter
- Replace engine shock mounts (refer to RM-02-02, Chapter 71-20.01; 71-20.02; 71-20.03)
- Replace v-ribbed belt (refer to RM-02-02, Chapter 72-20.01)
- Exchange coolant (refer to the aircraft manufacturer's specifications)
- Replace proportional pressure reducing valve (part of the gearbox)
- Inspect gearbox (refer to Chapter 6, Annex 15, Page 63 of this Manual)

■ CAUTION:

The 1200 hrs gearbox inspection interval is only valid for P/N:

05-7212-K0437 02 CD-155 14V

05-7212-K0438 02 CD-155 28V

05-7212-K0440 02 CD-155 28V DA42

05-7212-K0415 03 CD-155 14V

05-7212-K0416 03 CD-155 28V

05-7212-K0418 03 CD-155 28V DA42

or later approved revisions, in combination with the dual mass flywheel and the use of gearbox oil Shell Spirax S6 ATF ZM or CENTURION Gearbox Oil N1.

In all other cases, the interval remains at 300 or 600 hrs.

- Inspect timing chain
ONLY applicable for engines Version 02
(refer to RM-02-02, Chapter 05-20.04)

6.2.9 Every 1200 operating hours or every 24 months, whichever occurs first

- Exchange coolant
(refer to aircraft manufacturer's specifications)

6.2.10 Every 1500 operating hours

- Carry out all steps described in Section 6.2.4, Page 5 of this Chapter
- Inspect timing chain
ONLY applicable for engines Version 02
(refer to RM-02-02, Chapter 05-20.04)

6.2.11 Every 1500 operating hours (only applicable for CD-135)

- Replace engine shock mounts
(refer to RM-02-02, Chapter 71-20.01; 71-20.02; 71-20.03)

6.2.12 Every 1800 operating hours

- Carry out all steps described in Section 6.2.5, Page 6 of this Chapter
- Carry out all steps described in Section 6.2.6, Page 7 of this Chapter
- Inspect timing chain
ONLY applicable for engines Version 02
(refer to RM-02-02, Chapter 05-20.04)

6.3 Maintenance Actions based on Time

▲ **WARNING:** Under extreme conditions such as low usage combined with operation in a salt-water environment, or in a very dusty and sandy environment, shorter maintenance and inspection intervals are recommended for your own safety.

◆ **Note:** Chapter 1, Section 1.10, Page 5 of this Manual must be observed.

6.3.1 Every month

- Protect engine against corrosion. Start-up the engine for at least 20 minutes
(refer to Chapter 4, Section 4.2, Page 2 of this Manual)

6.3.2 Every 12 months

- Replace excitation battery of the alternator
(refer to Annex 16, Page 67 of this Chapter)
- Exchange engine oil and oil filter
(refer to Annex 5, Page 16 of this Chapter);
A sample of the oil and the used oil filter should be labeled, stored in a clean container and made available to Technify Motors GmbH on request for the complete engine life time. The sample will be required for a later long-run analysis. The label must show the aircraft serial number, registration number, engine serial number, operation time and date.
Quantity of oil to be taken for sample: 100ml
- Exchange gearbox oil and gearbox oil filter
(refer to Annex 13, Page 52 of this Chapter);
A sample of the oil and the used gearbox oil filter should be labeled, stored in a clean container and made available to Technify Motors GmbH on request for the complete engine life time. The sample will be required for a later long-run analysis. The label must show the aircraft serial number, registration number, engine serial number, operation time and date.
Quantity of oil to be taken for sample: 100ml

6.3.3

Every 24 months

- Exchange coolant
(refer to the aircraft manufacturer's specifications)

6.3.4

Every 60 months

- Replace all fuel, oil and cooling system lines
(refer to RM-02-02, Chapter 05-20.03.)

◆ Note:

Flexible hose / hose assemblies replacement times are in-service times. In-service times must be determined by

1. the date the aircraft was licensed, if new or
2. the date entered in the logbook for the replacement hose placed in service.

Do not use the date stamped on the hose / hose assembly, as time may be included for shelf life, and not in-service use.

-
- FADEC maintenance (to be carried out by the engine manufacturer)

Annex 1 Inspecting the V-Ribbed Belt

This is a general visual inspection. The v-ribbed belt is to be checked for indications of wear such as abrasion and cracks. The v-ribbed belt tension is determined by spring pressure automatically.

Annex 2 **Inspecting the Oil and Fuel System for Leakage**

This is a visual inspection. Check all pipes, pipe joints, supply connections and engine housing separation points (e.g. cylinder head gasket, cylinder head cover gasket) for leakage, seepage points and correct routing. Visual inspection of oil for water contamination and water for oil contamination. For more details see RM-02-02 Chapter 05-20.03.

▲ WARNING: No leaks or seepage points are permitted!

Annex 3 **Inspecting the Cooling System for Leakage**

This is a visual inspection. The pipes, pipe joints and supply connections are inspected for leakage and seepage points.

▲ WARNING:

No leakage and seepage points are permitted! No coolant loss during operation is permitted! Any coolant loss must be followed immediately by a technical inspection, as this can lead to engine damage and failure!

Annex 4 Engine Test Run

Check the starting behavior:

■ **CAUTION:** Do not overheat the starter. Do not operate the starter for more than 10 seconds. After operating the starter, let it cool down for 20 seconds. After six attempts to start the engine, let the starter cool down for half an hour.

1. Start the engine according to Chapter 4, Section 4.2, Page 2 of this Manual.
2. Warm up the engine according to Chapter 4, Section 4.3, Page 3 of this Manual.
3. Perform the engine test run according to Chapter 4, Section 4.4.2, Page 5 of this Manual.
4. Shut down the engine according to Chapter 4, Section 4.7, Page 9 of this Manual.

Annex 5 Exchanging the Engine Oil and Oil Filter

1. Allow the engine to warm up, refer to Chapter 4.2 and Chapter 4.3 of this manual.

▲ **WARNING:** The engine warm-up must be conducted in a secure that is protected from the unauthorized movement of personnel! Any rotating propeller is a potential safety hazard that can cause severe personal injuries or even death!

■ **CAUTION:** After the engine has been warmed up, shut down the engine. Refer to Chapter 4.7 of this manual.

2. Drain the engine oil from the oil sump by unscrewing the drain plug (a) and allow the oil to drain. See Fig. 6.1.

■ **CAUTION:** The regulations regarding the disposal of waste oil must be observed. Never discharge waste oil into the sewage system or to the ground.

◆ **Note:** A sample of the oil and the used oil filter must be labeled, stored in a clean container and made available to Technify Motors GmbH on request for the complete engine life time. The label must show the aircraft serial number, registration number, engine serial number, operation time and date. Quantity of oil sample: 100ml



Fig. 6.1 Oil drain plug
a Oil drain plug

3. Replace the seal ring (P/N: NM-0000-0014001) at the drain plug.
4. Refit the drain plug and tighten it up to the specified tightening torque.
Tightening Torque:
20 Nm (177 inch-lbs.)
5. Secure the drain plug with a locking wire.
6. Remove the screw cap (b) together with the oil filter cartridge (c). See Fig. 6.2.

◆ **Note:** Check the oil filter cartridge for swarf and other signs of abrasion (e.g. from the bearings). Contact the Technify Motors GmbH if any are found.

7. Replace the o-ring (a) and then insert the new oil filter cartridge (c) into the screw cap (b). See Fig. 6.2.

■ **CAUTION:** Only use the original Technify Motors GmbH oil filter.

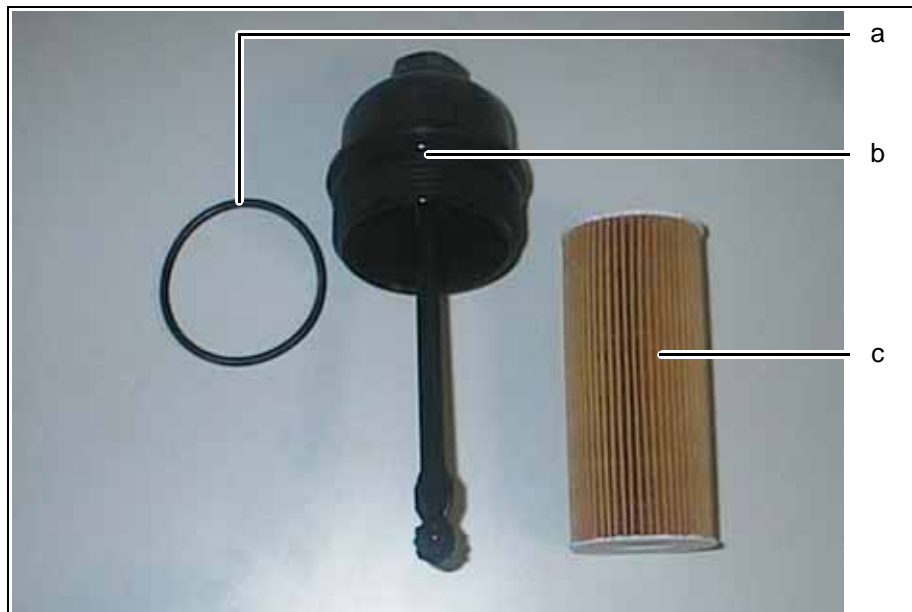

Fig. 6.2 Oil filter assy

- a O-ring, part of P/N 05-7253-K0044 01
- b Screw cap, P/N 05-7253-K00030x
- c Oil filter cartridge, P/N 05-7253-K0044 01

8. Refit the screw cap (b) and tighten it up to the specified tightening torque.
Tightening Torque:
25 Nm (221 inch-lbs.)

9. Refill the engine oil.

■ **CAUTION:** Only engine oil according to Chapter 3, Section 3.5, Page 4 of this Manual may be used.

◆ **Note:** Due to differences in the oil cooler installation the oil quantity depends upon the aircraft manufacturer. A min. and max. oil quantity is specified by the engine manufacturer for installations.
min.: 4.5 liters (1.2 gal)
max.: 6.0 liters (1.6 gal)

◆ **Note:** Before refilling, in order to mix the oil and the additives, either shake the engine oil bottle, or stir the oil barrel.

10. Check engine oil level.

◆ **Note:** After checking the engine oil level, screw in the dipstick completely.

11. Perform an Engine Test Run, refer to Annex 4 of this Chapter.

12. Check engine oil level. Refill, if necessary.

Annex 6 **Cleaning the Engine**

The engine must be cleaned with care. If leakage points are found, their positions must be clearly identified before they are cleaned. The engine must be cleaned only when it is cooled down. Generally, the use of cold cleaners is recommended (e.g. Eylert cleaner, Eylert P/N 89226)

■ **CAUTION:** Do not use any cleaners in the area of the clutch. Cleaners can damage the clutch!

■ **CAUTION:** The use of easily flammable and caustic cleaning agents is not allowed. Also, avoid cleaning the engine's electrical system, as this may be damaged. The use of high-pressure cleaning equipment is not allowed.

The engine must be dried after cleaning, ideally with compressed air (≤ 8 bar).

Annex 7 Checking the FADEC Sensors

This is a visual inspection. Check whether the plug connections of the sensors are firmly in place. In addition, the wiring harness has to be checked for indications of abrasion.

The sensors which should be checked are listed below:

-
- ◆ Note: The plugs marked "spare" and "diagnostic" are not connected to the wiring harness.
-



a

Fig. 6.3 Coolant temperature sensor

a Coolant temperature sensor

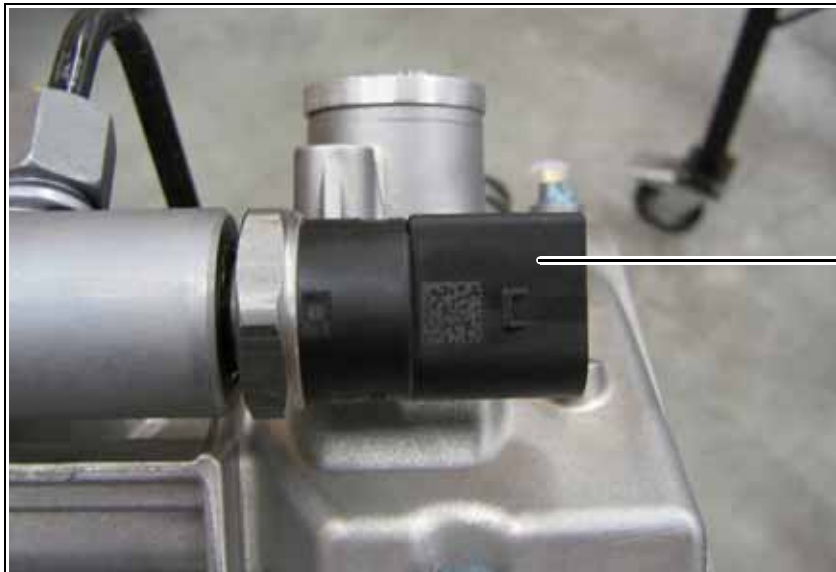

a

Fig. 6.4 Rail pressure sensor

a Rail pressure sensor

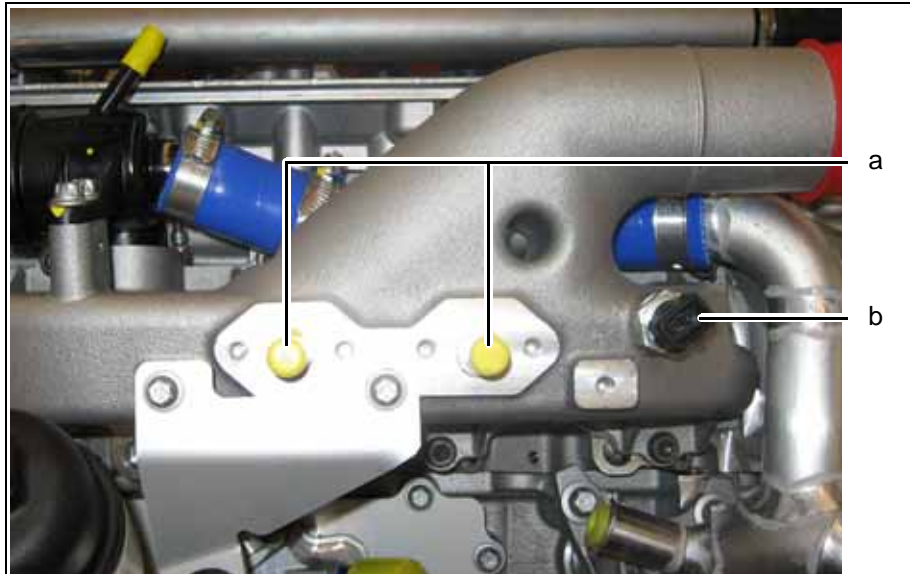

Fig. 6.5 Air temperature sensor and MAP connections of the intake manifold

- a FADEC connection for MAP sensor
- b Air temperature sensor



Fig. 6.6 Camshaft sensor 1

- a Camshaft sensor FADEC A (1 of 2)



Fig. 6.7 Camshaft sensor 2
a Camshaft sensor 2 FADEC B (2 of 2)



Fig. 6.8 Crankshaft sensor 1
a Crankshaft sensor FADEC A (1 of 2)

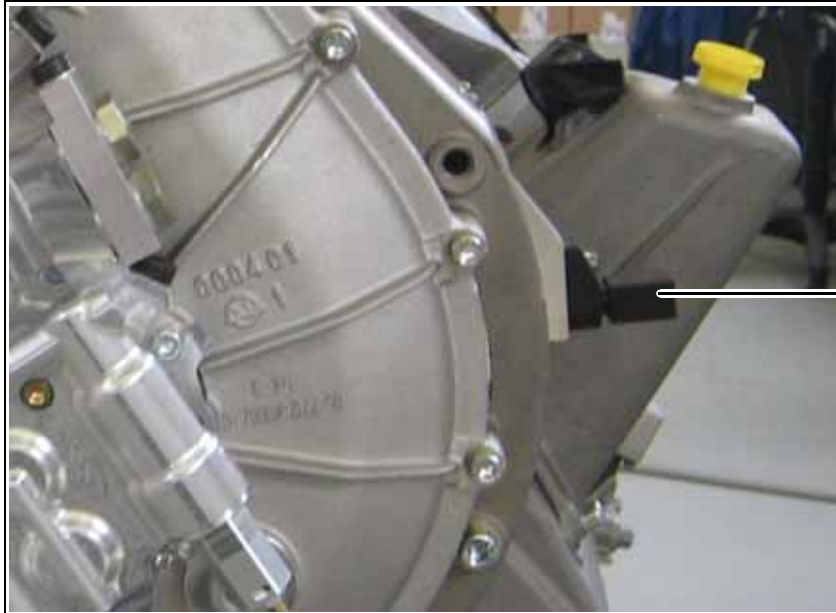

Fig. 6.9 Crankshaft sensor 2
a Crankshaft sensor FADEC B (2 of 2)



Fig. 6.10 Gearbox temperature sensor
a Gearbox temperature sensor

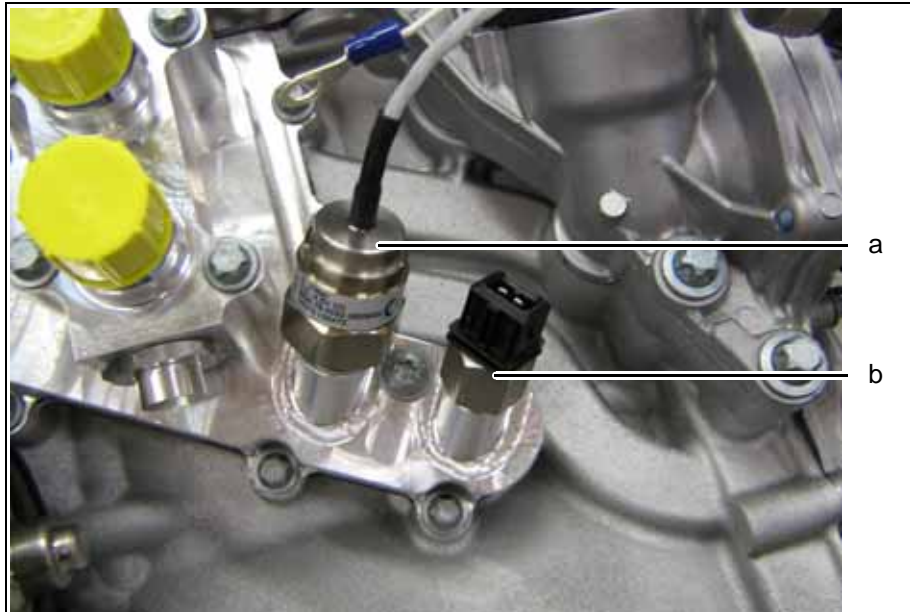

Fig. 6.11 Oil pressure- and oil temperature sensor

- a Oil pressure sensor
- b Oil temperature sensor

Annex 8 Exchanging the gearbox oil filter of the gearbox

Gearbox with oil cooler:

| Item | Part Number | Description 1 | Description 2 | Quantity |
|------|-----------------|----------------|--------------------------|----------|
| 1 | 03-7212-K004001 | Filter element | | 1 |
| 2 | NM-0000-0150401 | O-Ring | DIN 3771-25x2,5-80FKM610 | 1 |

1. Loosen the filter cap of the gearbox oil filter and remove it. Catch draining oil with an appropriate container. See Fig. 6.12.

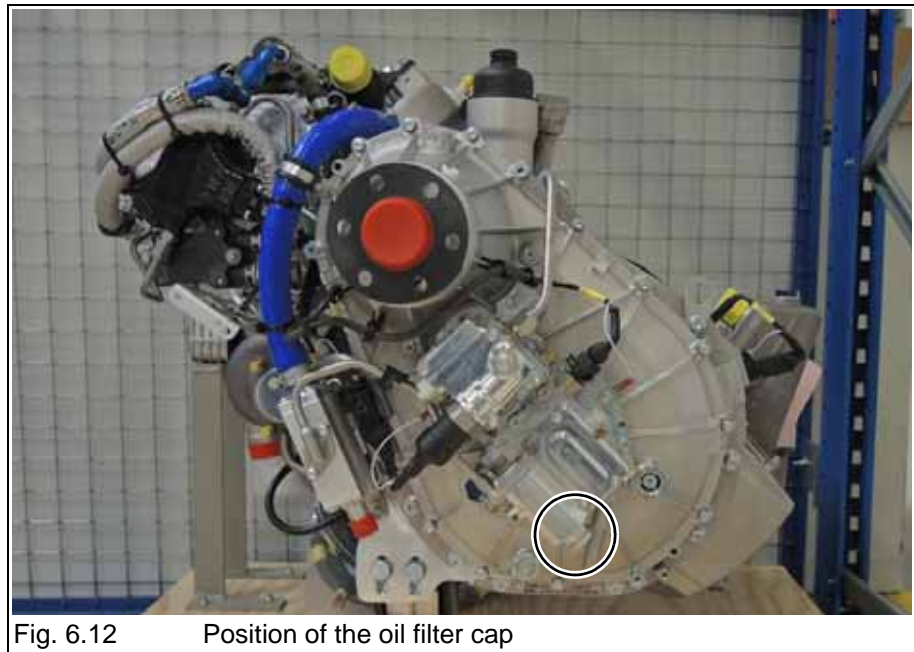

2. Remove the old gearbox oil filter with a M6 screw.

◆ **Note:** The used gearbox oil filter must be labeled, stored in a clean container and made available to Technify Motors GmbH on request for the complete engine life time. The label must show the aircraft serial number, registration number, engine serial number, operation time and date.

3. Insert the new gearbox oil filter. For mounting direction see Fig. 6.13 and Fig. 6.14.

■ **CAUTION:** Only use an original Technify Motors GmbH gearbox oil filter.

◆ **Note:** Make sure that the new o-ring is correctly mounted to the new oil-filter. The o-ring is part of the new oil filter (Item 1).



Fig. 6.13 Mounting direction of the oil filter

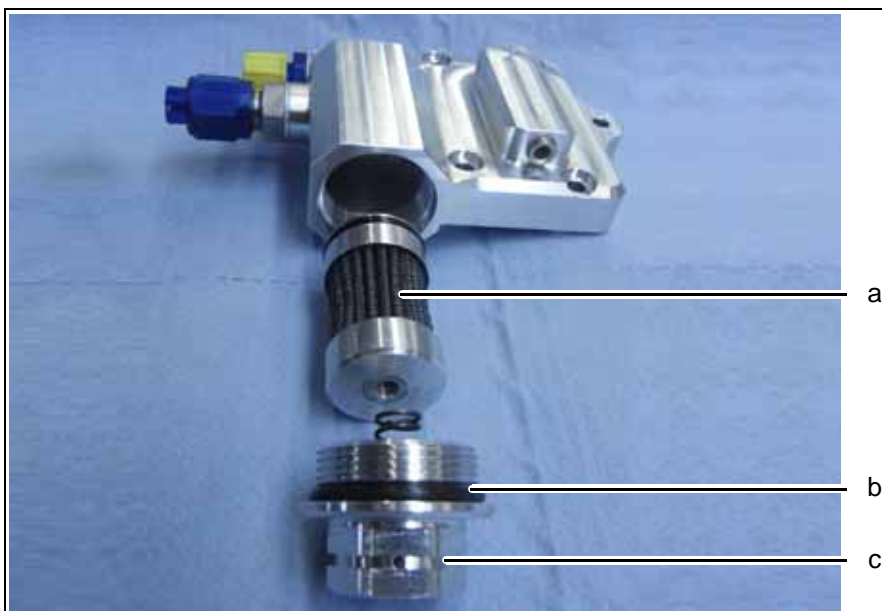

Fig. 6.14 Gearbox oil filter assembling

- a Filter element with o-ring
- b O-ring
- c Filter cap with spring

4. Attach the new o-ring to the filter cap. See Fig. 6.14.

◆ **Note:** Make sure that the spring in the filter cap is fixed.

5. Remount the filter cap and tighten it to the specified tightening torque.
Tightening Torque:
30 Nm
6. Preset the proportional pressure reducing valve (refer to Chapter 72-10.16 of RM-02-02).
7. Secure the gearbox oil filter cap with a locking wire. See Fig. 6.15.



Fig. 6.15 Lock wiring between oil drain plug and oil filter cap

8. Do an Engine Test run according to Annex 4 of this Chapter.
9. Do a visual inspection and a check for leaks.
10. Check the gearbox oil level according to Annex 9 of this Chapter.

Gearbox without oil cooler

| Item | Part Number | Description 1 | Description 2 | Quantity |
|------|-----------------|----------------|--------------------|----------|
| 1 | 03-7212-K004001 | Filter element | | 1 |
| 2 | NM-0000-0121001 | Sealing Ring | DIN 7603-A30x36-AI | 1 |

1. Loosen the filter cap of the gearbox oil filter and remove it. Catch draining oil with an appropriate container. See Fig. 6.16.



Fig. 6.16 Position of the oil filter cap

2. Remove the old gearbox oil filter with a M6 screw. See Fig. 6.17.

◆ **Note:** The used gearbox oil filter must be labeled, stored in a clean container and made available to Technify Motors GmbH on request for the complete engine life time. The label must show the aircraft serial number, registration number, engine serial number, operation time and date.



Fig. 6.17 Removal of gearbox oil filter

3. Insert the new gearbox oil filter. For mounting direction see Fig. 6.18 and Fig. 6.19.

■ **CAUTION:** Only use an original Technify Motors GmbH gearbox oil filter.

◆ **Note:** Make sure that the new o-ring is correctly mounted to the new oil-filter. The o-ring is part of the new oil filter (item 1).



Fig. 6.18 Gearbox oil filter assembling

- a Filter element with o-ring
- b Sealing ring (aluminum)
- c Filter cap with spring



Fig. 6.19 Mounting direction of the oil filter

4. Attach the new aluminum sealing ring to the filter cap. See Fig. 6.19.

◆ **Note:** Make sure that the spring in the filter cap is fixed.

5. Remount the filter cap and tighten it to the specified tightening torque.
Tightening Torque:
55 Nm
6. Preset the proportional pressure reducing valve. Refer to Chapter 72-10.05 of RM-02-02.
7. Secure the gearbox oil filter cap with a locking wire. See Fig. 6.20.



Fig. 6.20 Lock wiring the oil filter cap, the proportional pressure reducing valve and the gearbox housing

8. Do an Engine Test run according to Annex 4 of this Chapter.
9. Do a visual inspection and a check for leaks.
10. Check the gearbox oil level according to Annex 9 of this Chapter.

Annex 9 Checking the level of the gearbox oil of the gearbox

Gearbox with oil cooler:

| Item | Part Number | Description 1 | Description 2 | Quantity |
|---------------------------------------|-----------------|---------------|--------------------|----------|
| Required if oil needs to be refilled: | | | | |
| 1 | NM-0000-0021701 | Sealing Ring | DIN 7603-A18x24-AI | 1 |

■ **CAUTION:** Only use gearbox oil, which is specified in Chapter 3, Section 3.5, Page 3 of this Manual.

1. Check oil level through the inspection glass of the gearbox. The oil level must reach the top of the inspection glass, air bubbles must not be visible. See Fig. 6.21.

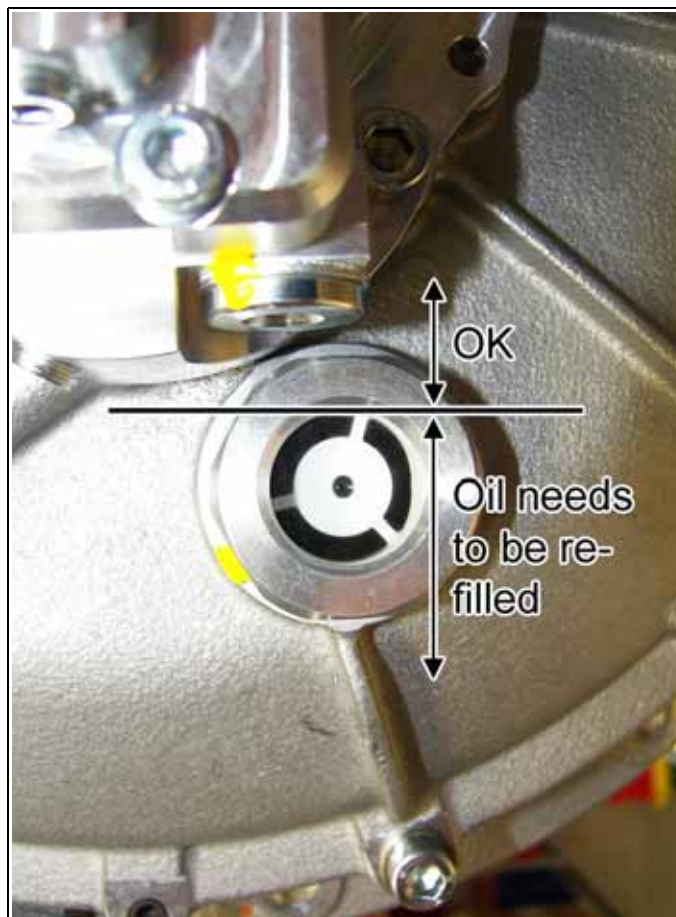

Fig. 6.21 Check the oil level

2. If the oil level is not OK, check the gearbox for leaks.
3. If leaks were found contact Technify Motors GmbH, if no leaks were found do the following work steps.

- If oil needs to be refilled loosen the oil filler screw and remove it. See Fig. 6.22.

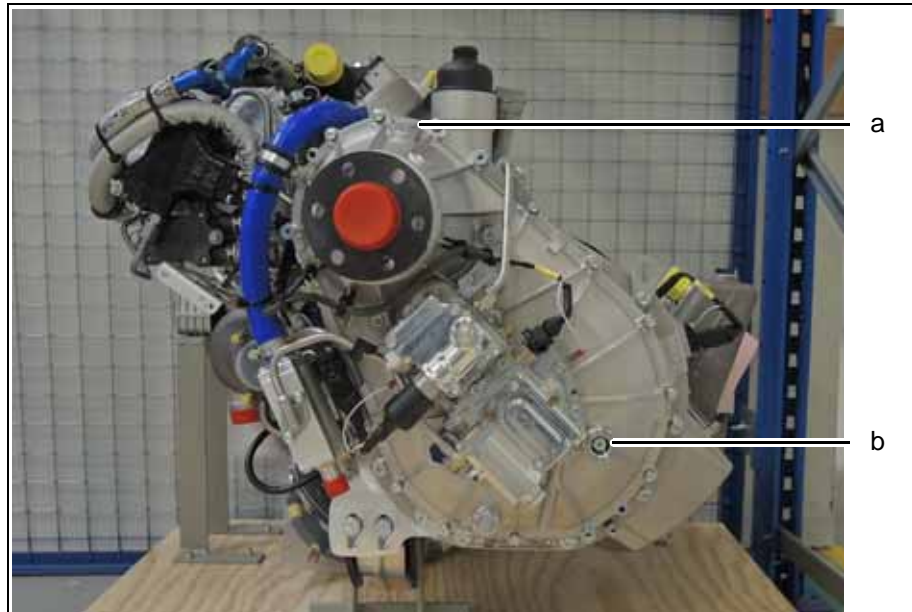

Fig. 6.22 Gearbox oil filler screw and inspection glass

- a Oil filler screw
- b Oil level inspection glass

- Fill in the new gearbox oil until the oil level reaches the top border of the oil level inspection glass (Marking line in Fig. 6.21). Air bubbles must not be visible.

◆ **Note:** Before refilling, shake the gearbox oil bottle, in order to mix the gearbox oil and the additives.

- Fill another 150ml of the new gearbox oil to reach the ideal oil level.
- Remount the oil filler screw with a new sealing ring and tighten it to the specified tightening torque.
Tightening Torque:
35 Nm
- Preset the proportional pressure reducing valve. Refer to Chapter 72-10.16 of RM-02-02.

9. Secure the oil filler screw with a lock wire. See Fig. 6.23.



Fig. 6.23 Lock wiring the oil filler screw

10. Do an Engine Test run according to Annex 4 of this Chapter.
11. Do a visual inspection and a check for leaks.
12. Check the gearbox oil level again.

Gearbox without oil cooler:

| Item | Part Number | Description 1 | Description 2 | Quantity |
|---------------------------------------|-----------------|---------------|--------------------|----------|
| Required if oil needs to be refilled: | | | | |
| 1 | NM-0000-0021701 | Sealing Ring | DIN 7603-A18x24-AI | 1 |

■ **CAUTION:** Use only gearbox oil which is specified in Chapter 3, Section 3.5, Page 3 of this Manual

1. Check oil level through the inspection glass of the gearbox. The oil level must reach the top of the inspection glass, air bubbles must not be visible. See Fig. 6.24.

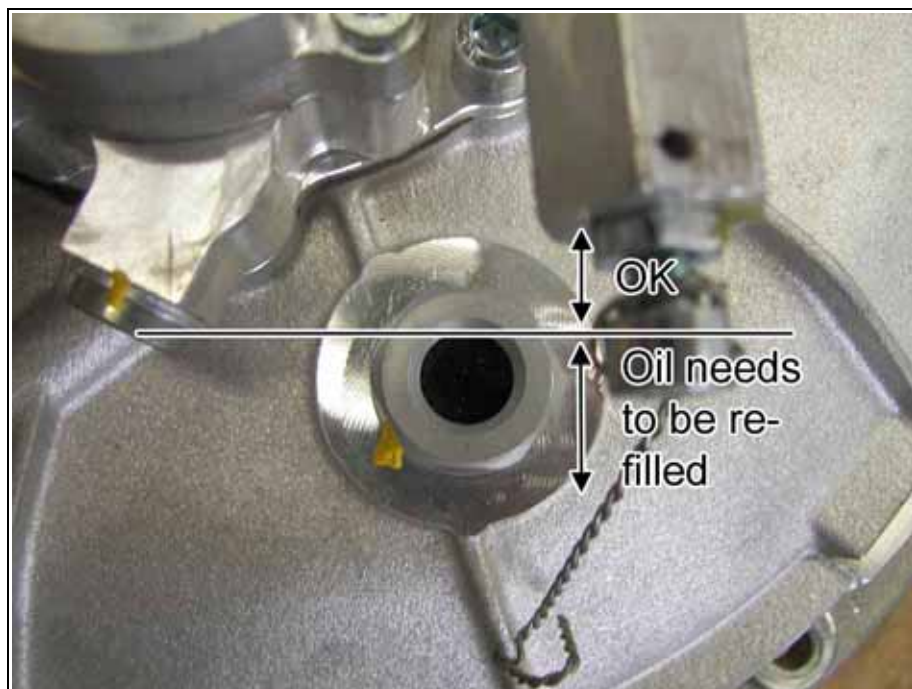

Fig. 6.24 Check the oil level

2. If the oil level is not OK, check the gearbox for leaks.
3. If leaks were found contact Technify Motors GmbH, if no leaks were found do the following work steps.
4. If oil needs to be refilled loosen the oil filler screw and remove it. See Fig. 6.25.



Fig. 6.25 Gearbox oil filler screw and inspection glass

- a Oil filler screw
- b Oil level inspection glass

5. Fill in the new gearbox oil until the oil level reaches the top border of the oil level inspection glass (marking line in Fig. 6.24). Air bubbles must not be visible.

◆ **Note:** Before refilling, shake the gearbox oil bottle, in order to mix the gearbox oil and the additives.

6. Remount the oil filler screw with a new sealing ring and tighten it to the specified tightening torque.
Tightening Torque:
35 Nm
7. Preset the proportional pressure reducing valve. Refer to Chapter 72-10.05 of RM-02-02.

- Secure the oil filler screw with a lock wire. See Fig. 6.26.



Fig. 6.26 Lock wiring the oil filler screw

- Do an Engine Test run according to Annex 4 of this Chapter.
- Do a visual inspection and a check for leaks.
- Check the gearbox oil level again

Annex 10 FADEC Read-out

1. General

The FADEC service tool is designed to provide the user access to Real time data, the onboard logger system as well as the event log information available from the Technify Motors GmbH FADEC system, and to facilitate organizing the data and to send this data to Technify Motors GmbH.

The tool is a requirement for standard maintenance as well as troubleshooting of the powerplant. This document provides instructions for using the software. Consult the operation & maintenance manual, the fault isolation manual as well as other available documentation for instructions and limitations of operation, maintenance, repair and troubleshooting. Routine maintenance must consist of a regular maintenance download and include:

- Event Log (FADEC DATA)
- Real Time Log File from Ground Run
(refer to Chapter 4, Section 4.4.2, Page 5 of this Manual for ground run procedures and requirements)

and shall be sent to:

eventlog@continentaldiesel.de

Request for diagnosis must consist of an extended download and must include all of the above plus

- download of the onboard logger (both ECUs),
- a detailed description of the abnormality.

and shall be sent to

support@continentaldiesel.de

The software tool is capable of providing the appropriate download in a single operation to reduce time and effort spent by the user. Please proceed to section 4 or 5 of this annex, as appropriate to perform a regular maintenance or an extended download.

-
- ◆ Note: Please use a compressed file format such as .zip to send any data. This greatly reduces transfer times and facilitates data handling on both sides. The tool offers this function automatically for the regular maintenance download and the extended download. After completing the download (maintenance or extended), the folder for the desired engine will contain a compressed file including all relevant data. Please send only one compressed file containing all the appropriate data for the event.
-

2. Viewing the Event Log

-
- ◆ Note: The Tool gives the user the capability to view the eventlog separately. This is not generally necessary, as the tool provides all necessary files in a single download. Please proceed to section 4 or 5 of this annex as appropriate.
-

The event log may be viewed without generating a file. For data to be sent to Technify Motors GmbH, the complete download appropriate to the situation should be used. Refer to section 4 and 5.

- a) Establish CAN communication, by connecting the computer to the aircraft, starting the program and powering up the FADEC.
- b) Menu FADEC => Show Event Log

3. Generating a Real Time Log File

- ◆ **Note:** The Tool gives the user the capability to generate a Real Time Logfile separately. This is not generally necessary, as the tool provides all necessary files in a single download. Please proceed to section 4 of this annex.

A Realtime Logfile may be generated without additional download if necessary. For routine maintenance and diagnostic support from Technify Motors GmbH the complete download appropriate to the situation should be used. Refer to section 4 and 5 of this annex.

- a) Establish CAN communication by connecting the computer to the aircraft, starting the program and powering up the FADEC (Engine Master).
- b) Menu FADEC => Start Real Time Log File. The following screens will appear:

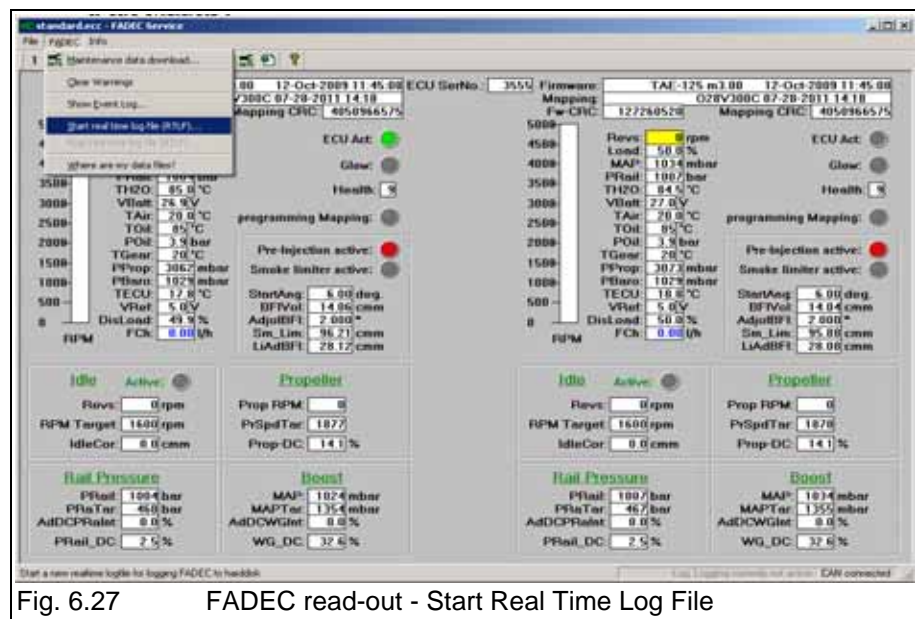

Fig. 6.27 FADEC read-out - Start Real Time Log File

Operation & Maintenance Manual

CD-135 / CD-155

OM-02-02

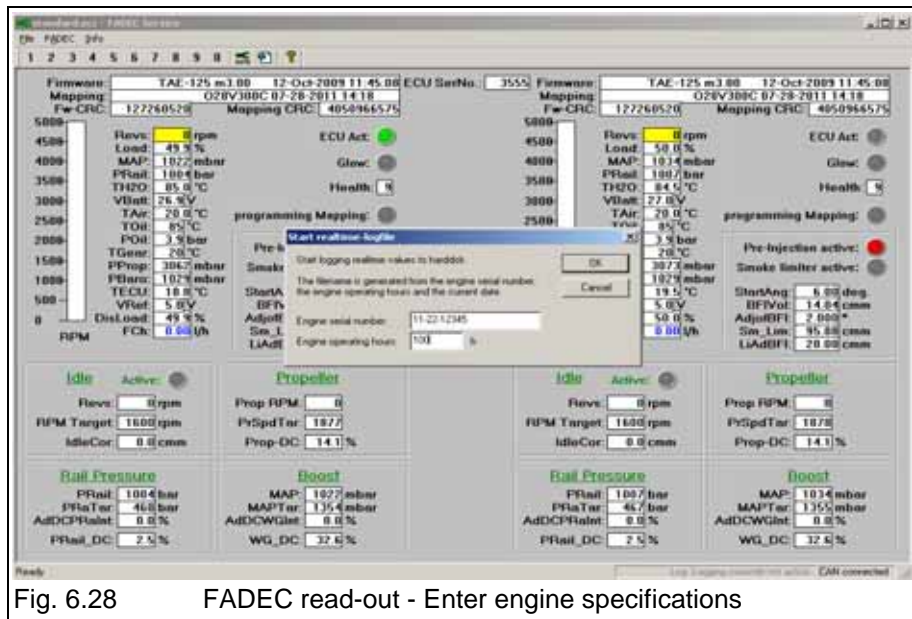

Fig. 6.28 FADEC read-out - Enter engine specifications

c) Enter the Engine S/N and Engine run time in the fields provided. Select OK. The window at the bottom right of the screen will indicate that the logging function is active by showing the file name in blue text.

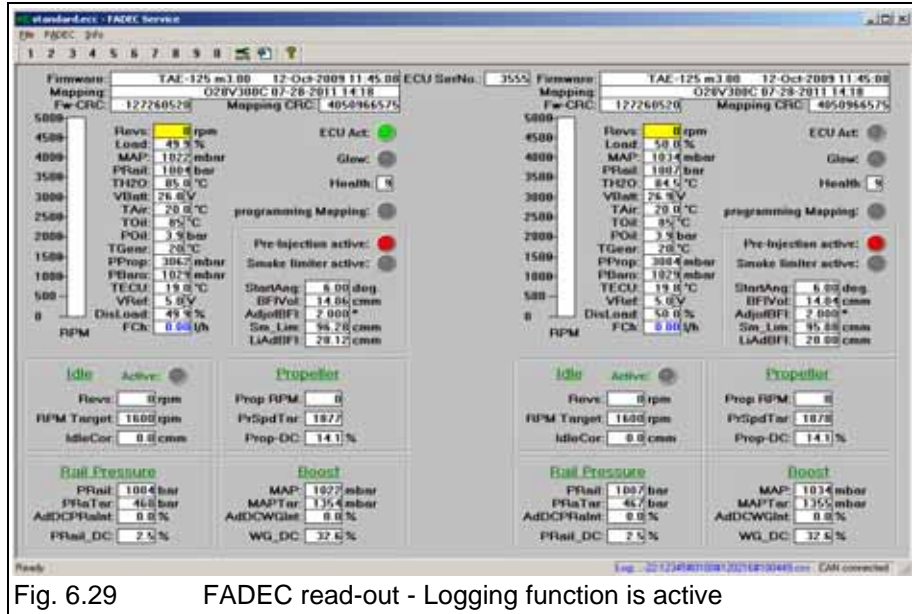

Fig. 6.29 FADEC read-out - Logging function is active

d) Conduct the engine Ground run according to the operating manual.

- ◆ **Note:** During the ground run, the user should verify that engine parameters are to spec. Compare the values of Map to MapTar, Prop RPM to PrSpdTAr and PRAil to PRArTar to determine any discrepancy.
- Manifold Pressure (MAP): Compare MAP to MAPTar. Deviation must be within a tolerance of 75 mbar.
 - Prospeed (Prop RPM): Compare PropRPM to PrSpdTAr. Deviation must be within a tolerance of +/-50 RPM.
 - Fuel Pressure (P-Rail): Compare PRAil to PRArTar. Deviation must be within a tolerance of +100/-70 bar.

e) Menu FADEC => Stop RTLF. The following screens will appear:

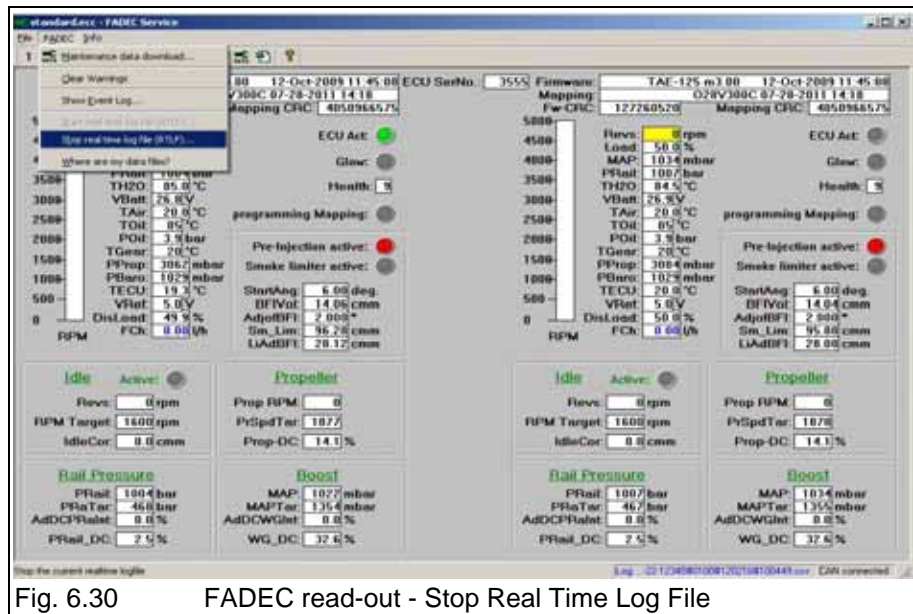

Fig. 6.30 FADEC read-out - Stop Real Time Log File

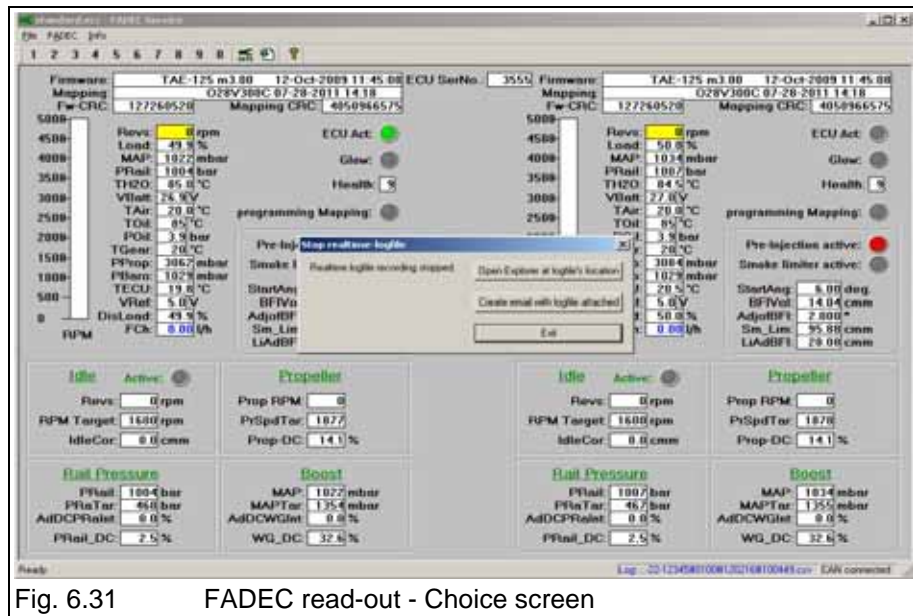

Fig. 6.31 FADEC read-out - Choice screen

- f) Select the action you wish to perform:
- Open Explorer at Logfile's location to locate the file just created
 - Create E-Mail with logfile attached if you wish to send the mail
 - Exit to return to the screen

4. Regular Maintenance Event

◆ Note: Please send only the compressed (.zip) file generated by the tool to Technify Motors GmbH. This file will already include the eventlog and the real time log file. It is not necessary to attach these again.

◆ Note: Depending on the engine's operating hours the data download may take up to 10 minutes.

The maintenance software tool has the ability to generate a single compressed file containing the data necessary during a regular maintenance event. This function should be used after a regular maintenance event.

- a) Menu FADEC => Maintenance Data Download. The following screens will appear:

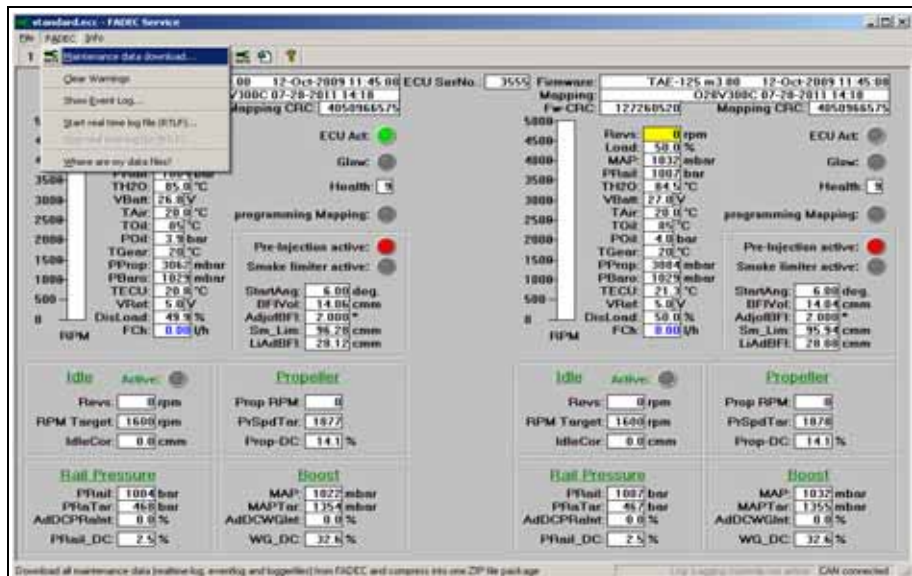

Fig. 6.32 FADEC read-out - Maintenance data download

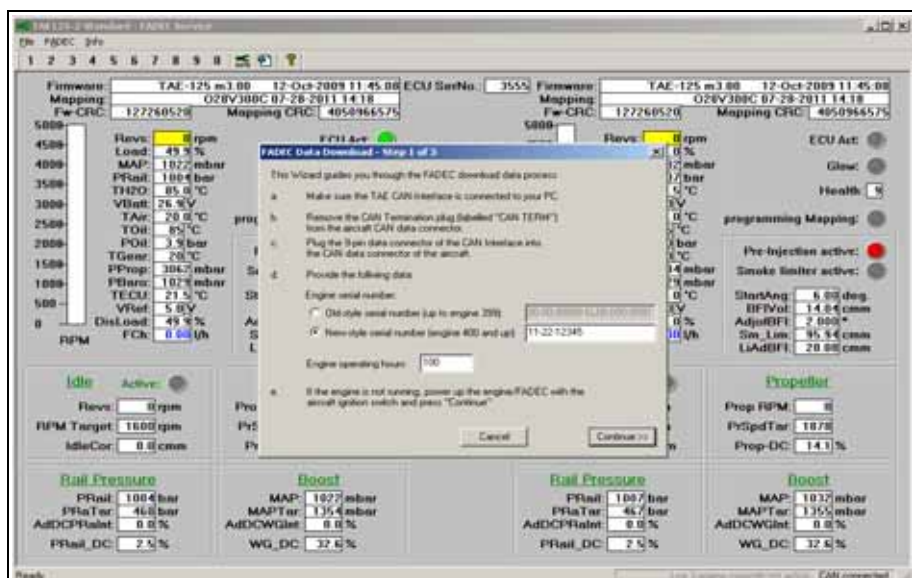

Fig. 6.33 FADEC read-out - Enter engine specifications

- b) If not already active, establish CAN communication with the FADEC by following the steps on the screen. Enter the required engine S/N and engine run time. Select Continue. The following screen will appear:

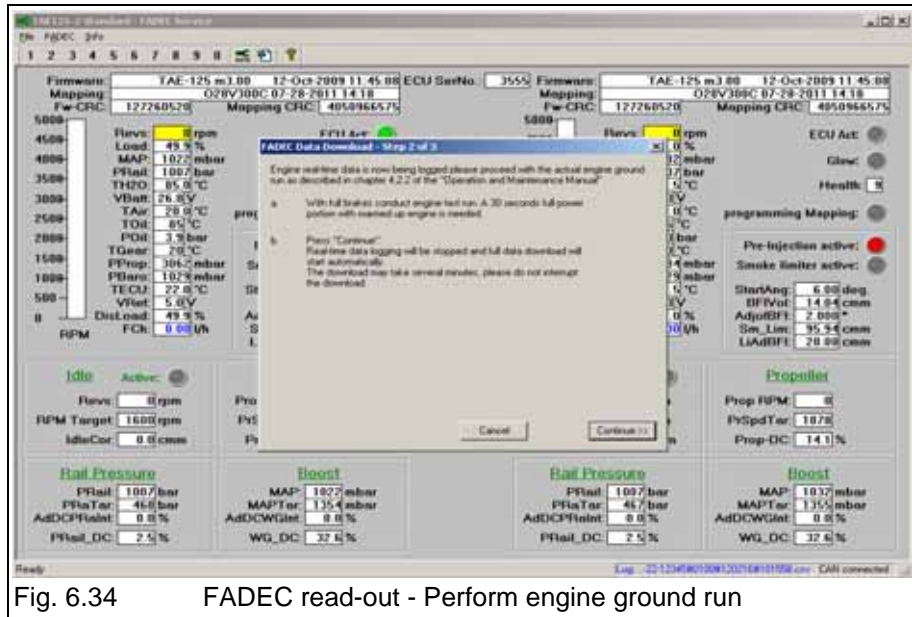

Fig. 6.34 FADEC read-out - Perform engine ground run

- c) Follow the instructions on the screen, performing the engine ground run according to Chapter 4, Section 4.4.2, Page 5 of this Manual. Press Continue. The following screen will appear:

◆ Note:

During the ground run, the user should verify that engine parameters are to spec.

Compare the values of Map to MapTar, Prop RPM to PrSpdTAr and PRail to PRaTar to determine any discrepancy.

- Manifold Pressure (MAP): Compare MAP to MAPTar. Deviation must be within a tolerance of 75 mbar.
- Propspeed (Prop RPM): Compare PropRPM to PrSpdTAr. Deviation must be within a tolerance of +/-50 RPM.
- Fuel Pressure (P-Rail): Compare PRail to PRaTar. Deviation must be within a tolerance of +100/-70 bar.

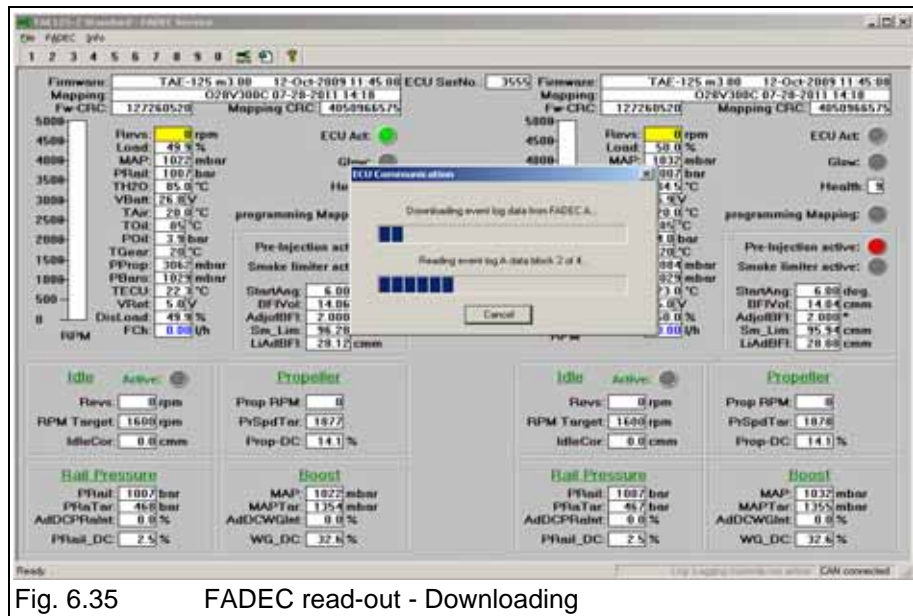

d) When the download is completed, the following screen will appear:

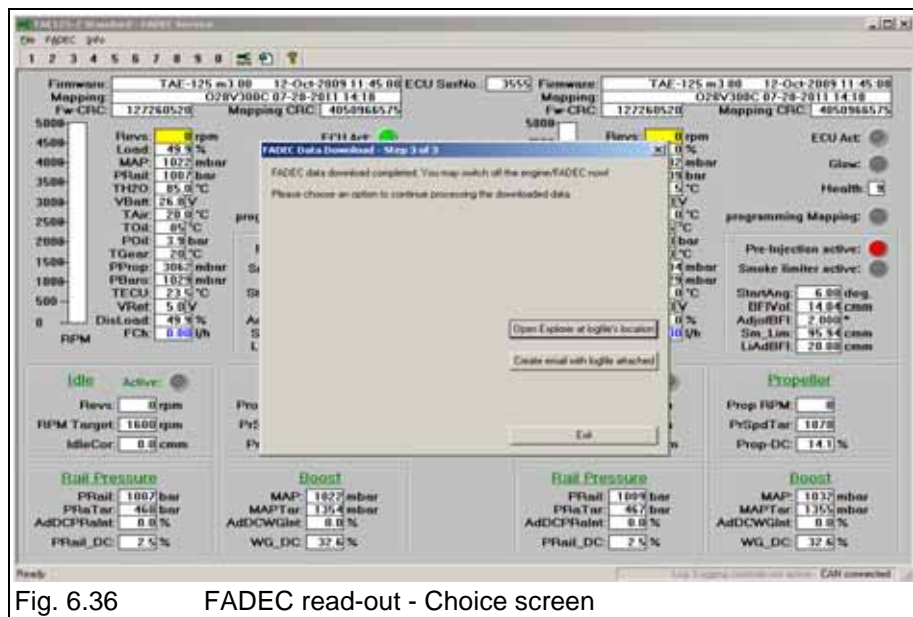

e) Select the action you wish to perform:

- Open Explorer at Logfile's location to locate the file just created
- Create E-Mail with logfile attached if you wish to send the mail

- Exit to return to the main screen

◆ Note: The files generated from this download will include a real time log file, the event log, logger files and a zip file containing all of the above. Refer to section 5 for additional information.

5. Locating/Sending Files

After performing a download, the tool compresses all files associated with that download into a single file with the format

EngineS/N#enginertime#date#time

The FADEC tool stores these files into a separate folder for each engine.

The general folder may be accessed through the following Menu:

FADEC => Where are my data files?

Or by selecting the appropriate icon after the download completes.

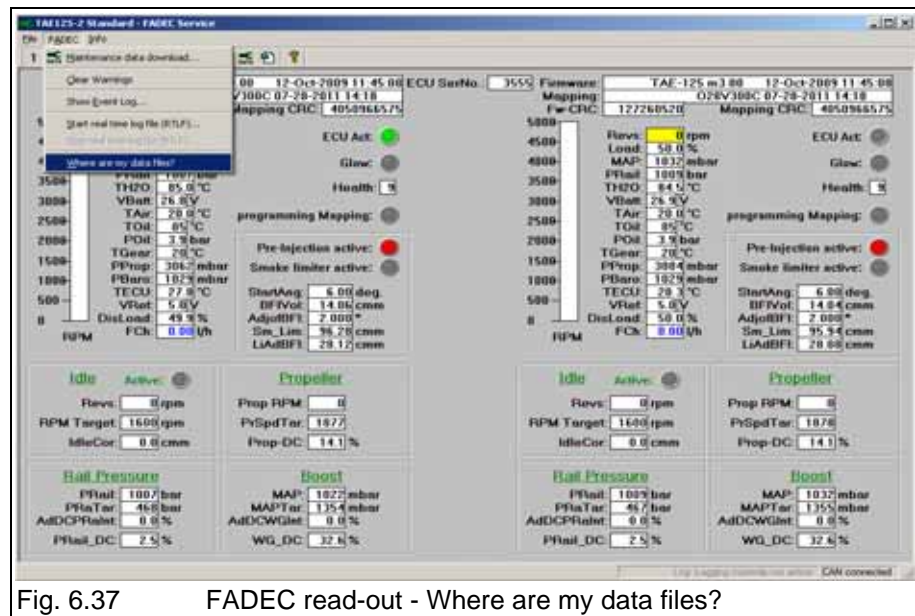

Fig. 6.37 FADEC read-out - Where are my data files?

Refer to instructions in your e-mail program for attaching files and for sending the files.

After a download completes, the FADEC is also able to attach the compressed files to an e-mail to the appropriate Technify Motors GmbH account by selecting the appropriate icon. This works for most e-mail clients.

6. Clearing Diagnostic Warnings

Should the diagnostic warning lights be active, they must be cleared after the discrepancy has been diagnosed and resolved before the aircraft can be released for service.

a) Menu FADEC => Clear Warnings. The following screens will appear:

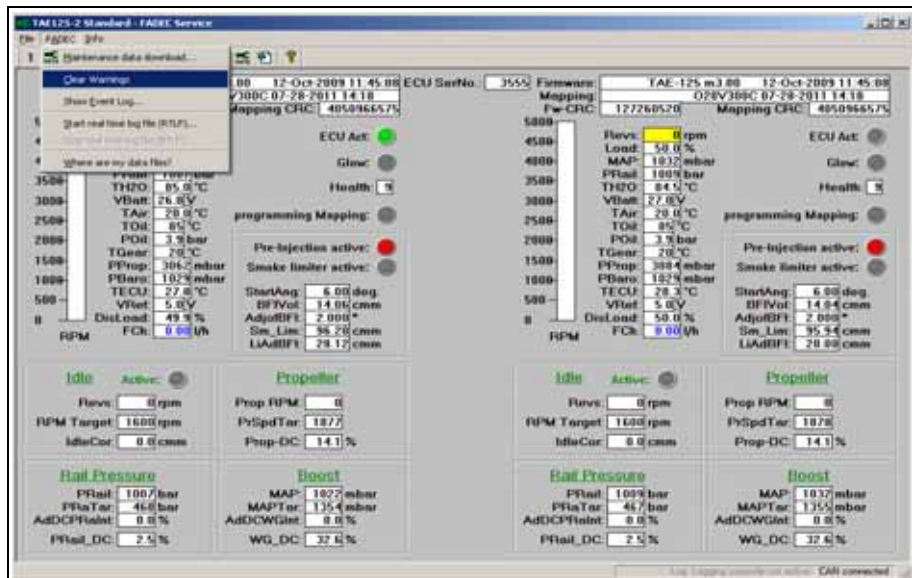

Fig. 6.38 FADEC read-out - Clear warnings

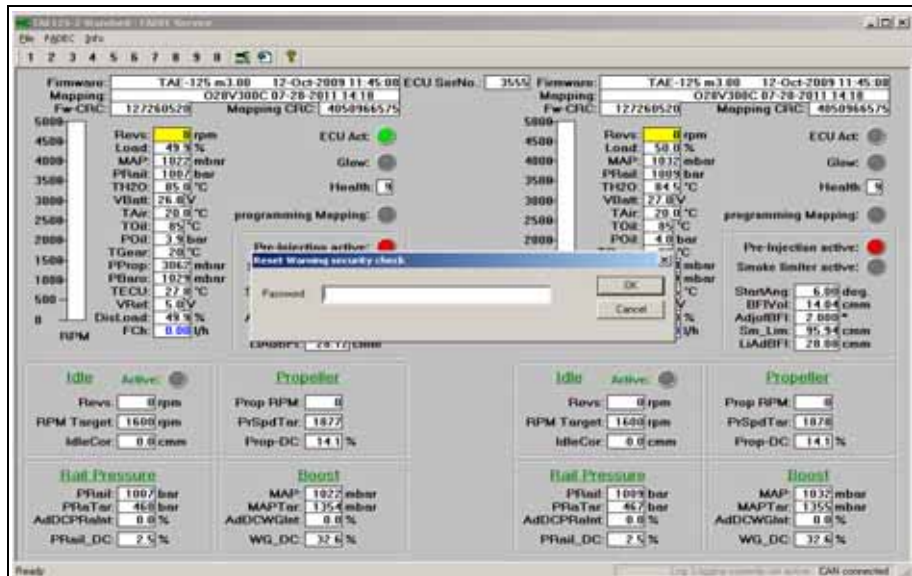

Fig. 6.39 FADEC read-out - Enter password

b) Enter the Password, select OK. The following screen will appear:

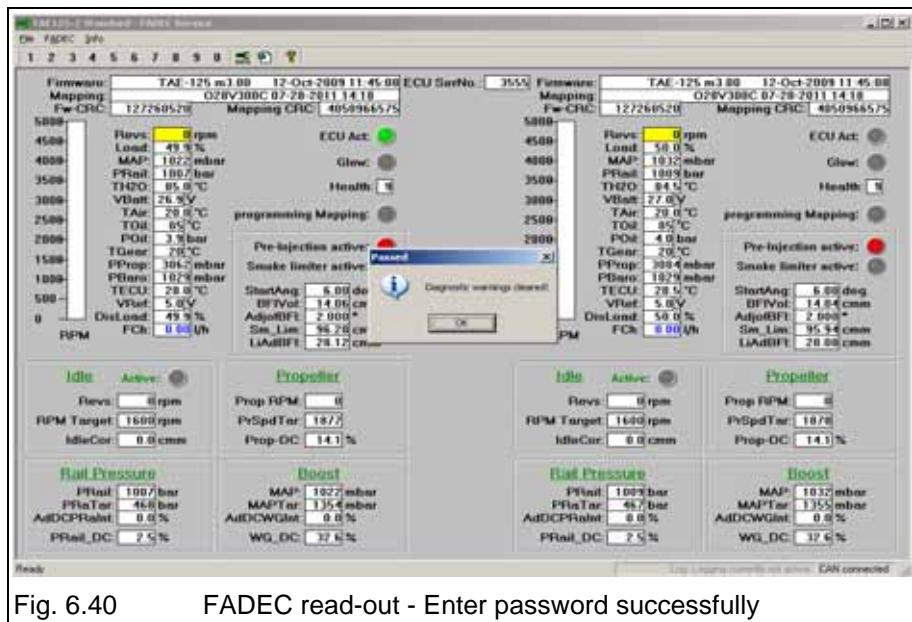

Fig. 6.40 FADEC read-out - Enter password successfully

c) Cycle ECU power and ensure that the lights on the panel have extinguished.

7. Selecting Different Screens

The tool allows access to various screens to view engine parameters, status of diagnostic warnings, as well as engine run statistics. Access these screens through the hotkeys at the top of the screen.

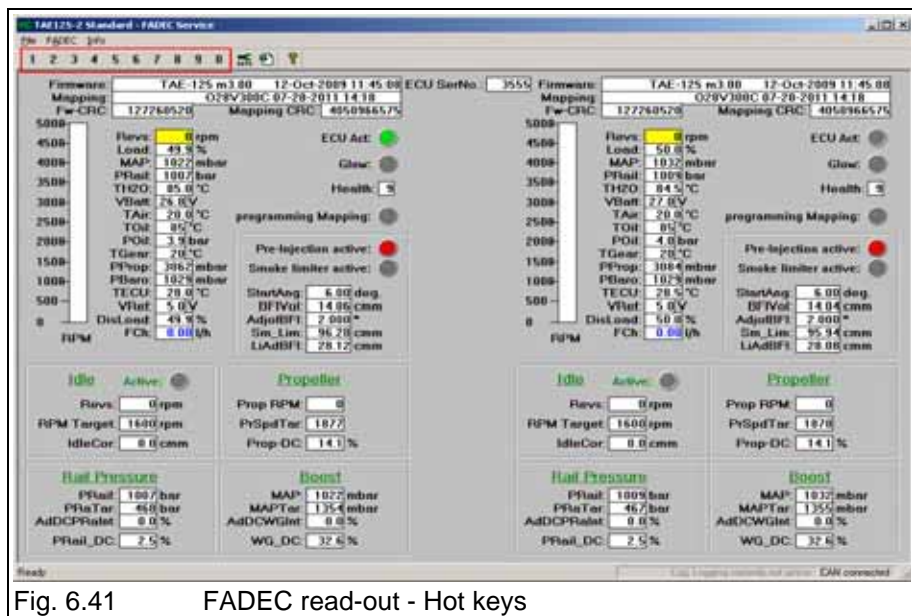

Fig. 6.41 FADEC read-out - Hot keys

Annex 11 Inspecting the High-Pressure Pump

The high-pressure pump must be delivered to Technify Motors GmbH for maintenance.

To remove and install the high-pressure pump, refer to RM-02-02.

Annex 12 Replacing the Alternator

The alternator must be delivered to Technify Motors GmbH for maintenance.

To remove and install the alternator, refer to RM-02-02.

Annex 13 Exchanging the gearbox oil and the gearbox oil filter at the gearbox

Gearbox with oil cooler:

| Item | Part Number | Description 1 | Description 2 | Quantity |
|------|-----------------|----------------|--------------------------|----------|
| 1 | 03-7212-K004001 | Filter element | | 1 |
| 3 | NM-0000-0150401 | O-Ring | DIN 3771-25x2,5-80FKM610 | 1 |
| 5 | NM-0000-0021701 | Sealing Ring | DIN 7603-A18x24-AI | 1 |
| 6 | NM-0000-0188601 | Sealing Ring | 18x24x1,5-Viton 80 | 1 |

■ **CAUTION:** The regulations regarding the disposal of waste oil must be observed. Never discharge waste oil into the sewage system or the ground.

■ **CAUTION:** Only use an original Technify Motors GmbH gearbox oil filter. Use only gearbox oil which is specified in Chapter 3, Section 3.5, Page 3 of this Manual.

1. Warm up the engine until the gearbox oil has a temperature of 50°C.
2. Loosen the oil drain plug of the gearbox. Catch the oil with an appropriate container. See Fig. 6.42.

■ **CAUTION:** The regulations regarding the disposal of waste oil must be observed. Never discharge waste oil into the sewage system or the ground.

◆ **Note:** Fill 100ml of the used gearbox oil in a clean container and put a label on the container. This oil-sample must be made available to Technify Motors GmbH on request for the complete engine life time. The label must show the aircraft serial number, registration number, engine serial number, operation time and the date.

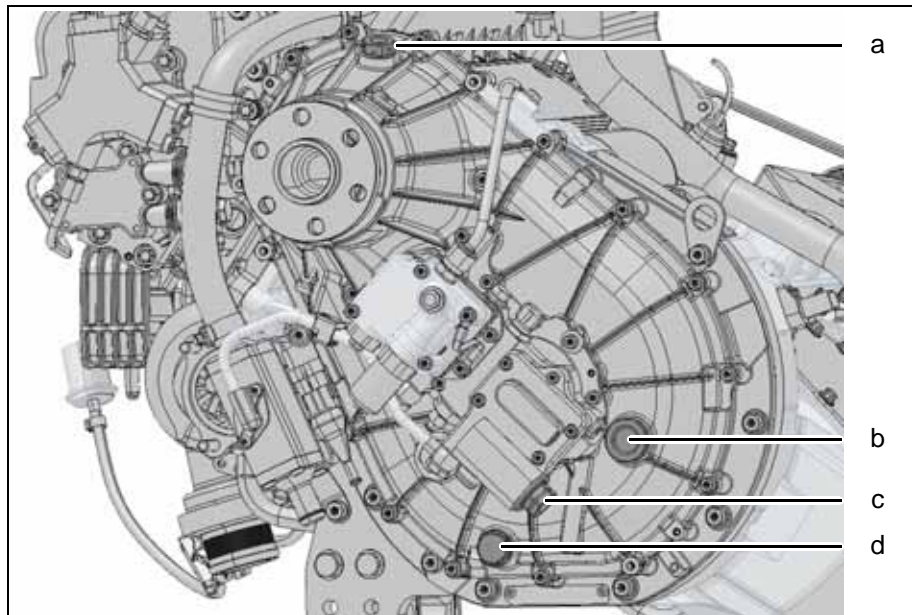

Fig. 6.42 Overview of the gearbox inspection points

- a Oil filler screw
- b Oil level inspection glass
- c Oil filter cap
- d Oil drain plug

3. Check the magnet of the oil drain plug for chips.

■ **CAUTION:** In case of any chips contact Technify Motors GmbH.

4. Remount the oil drain plug with a new sealing ring and tighten it to the specified tightening torque.

Tightening Torque:

25 Nm

- **CAUTION:** The sealing ring has 2 different sealing surfaces.
The plane surface of the sealing ring must face the magnet.

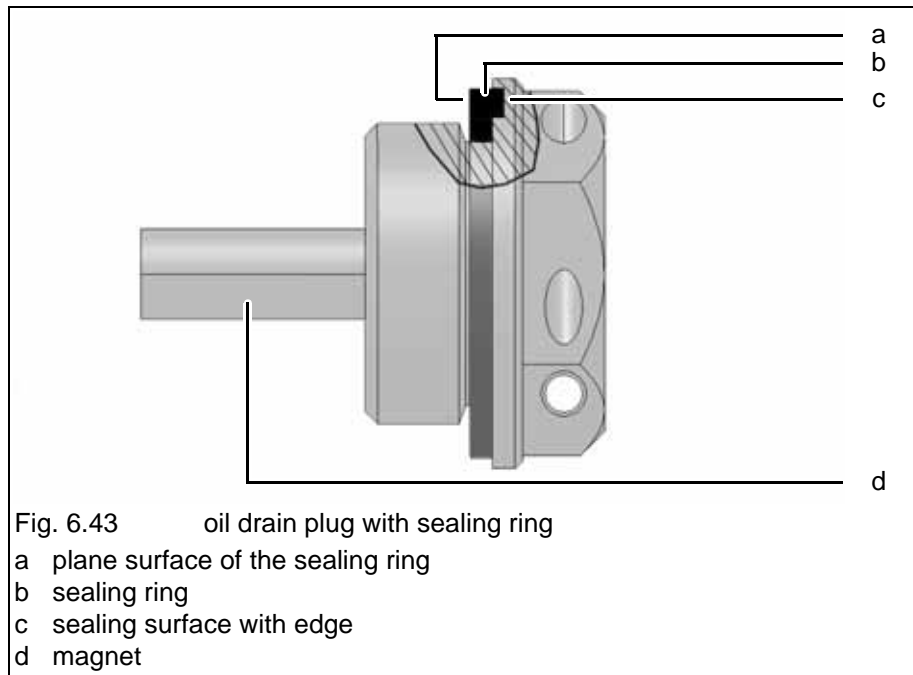

5. Loosen the filter cap of the gearbox oil filter and remove it. See Fig. 6.43.
6. Remove the oil filter with a M6 screw. See Fig. 6.44.

- ◆ **Note:** The used gearbox oil filter must be labeled, stored in a clean container and made available to Technify Motors GmbH on request for the complete engine life time. The label must show the aircraft serial number, registration number, engine serial number, operation time and date.



Fig. 6.44 Removal of gearbox oil filter

7. Insert the new gearbox oil filter. For mounting direction see Fig. 6.45 and Fig. 6.46.

■ **CAUTION:** Only use an original Technify Motors GmbH gearbox oil filter.

◆ **Note:** Make sure that the new o-ring is correctly mounted to the new oil-filter. The o-ring is part of the new oil filter (Item 1).



Fig. 6.45 Mounting direction of the oil filter

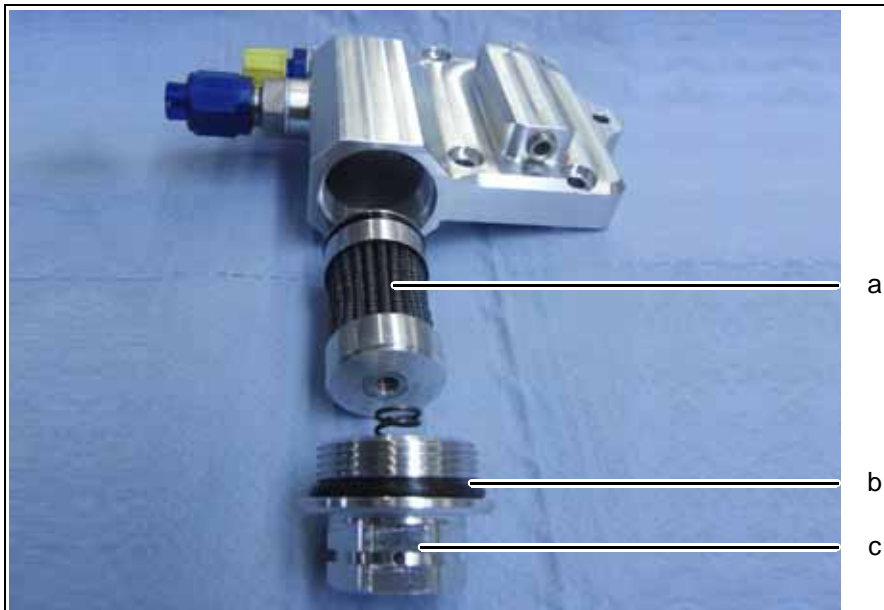

Fig. 6.46 Gearbox oil filter assembling

- a Filter element with o-ring
- b O-ring
- c Filter cap with spring

8. Attach the new o-ring to the filter cap. See Fig. 6.46.

◆ **Note:** Make sure that the spring in the filter cap is fixed.

9. Remount the filter cap and tighten it to the specified tightening torque.
Tightening Torque:
30 Nm
10. Loosen the oil filler screw and remove it. See Fig. 6.43.
11. Fill in the new gearbox oil according to the following details:
 - DA42: 1.5 liters
 - every other aircraft: 1.2 liters

■ **CAUTION:** Do not overfill the gearbox!

■ **CAUTION:** Use only gearbox oil which is specified in Chapter 3, Section 3.5, Page 3 of this Manual.

◆ **Note:** Before refilling, shake the gearbox oil bottle, in order to mix the gearbox oil and the additives.

12. Remount the oil filler screw with a new sealing ring and tighten it to the specified tightening torque.
Tightening Torque:
35 Nm
13. Preset the proportional pressure reducing valve. Refer to Chapter 72-10.16 of RM-02-02.
14. Secure the oil drain plug and the gearbox oil filter cap with a locking wire. See Fig. 6.47.



Fig. 6.47 Lock wire between the oil drain plug and the filter cap

15. Secure the oil filler screw with a lock wire. See Fig. 6.48.



Fig. 6.48 Lock wiring the oil filler screw

16. Do an Engine Test run according Annex 4 of this Chapter.
17. Do a visual inspection and a check for leaks.
18. Check the gearbox oil level according to Annex 9 of this Chapter.

6 Gearbox without oil cooler

| Item | Part Number | Description 1 | Description 2 | Quantity |
|------|-----------------|----------------|--------------------|----------|
| 1 | 03-7212-K004001 | Filter element | | 1 |
| 4 | NM-0000-0121001 | Sealing Ring | DIN 7603-A30x36-AI | 1 |
| 5 | NM-0000-0021701 | Sealing Ring | DIN 7603-A18x24-AI | 1 |
| 6 | NM-0000-0188601 | Sealing Ring | 18x24x1,5-Viton 80 | 1 |

■ **CAUTION:** The regulations regarding the disposal of waste oil must be observed. Never discharge waste oil into the sewage system or the ground.

■ **CAUTION:** Only use an original Technify Motors GmbH gearbox oil filter. Use only gearbox oil which is specified in Chapter 3, Section 3.5, Page 3 of this Manual.

1. Warm up the engine until the gearbox oil has a temperature of 50°C.
2. Loosen the oil drain plug of the gearbox. Catch the oil with an appropriate container. See Fig. 6.49.

■ **CAUTION:** The regulations regarding the disposal of waste oil must be observed. Never discharge waste oil into the sewage system or the ground.

◆ **Note:** Fill 100 ml of the used gearbox oil in a clean container and put a label on the container. This oil-sample must be made available to Technify Motors GmbH on request for the complete engine life time. The label must show the aircraft serial number, registration number, engine serial number, operation time and the date.



Fig. 6.49 Overview of the gearbox inspection points

- a Oil filler screw
- b Oil level inspection glass
- c Filter cap
- d Oil drain plug

3. Check the magnet of the oil drain plug for chips.

■ **CAUTION:** In case of any chips contact Technify Motors GmbH.

4. Remount the oil drain plug with a new sealing ring and tighten it to the specified tightening torque.

Tightening Torque:
25 Nm

5. Loosen the filter cap of the gearbox oil filter and remove it. See Fig. 6.49.
6. Remove the oil filter with a M6 screw. See Fig. 6.50.

◆ **Note:** The used gearbox oil filter must be labeled, stored in a clean container and made available to Technify Motors GmbH on request for the complete engine life time. The label must show the aircraft serial number, registration number, engine serial number, operation time and date.

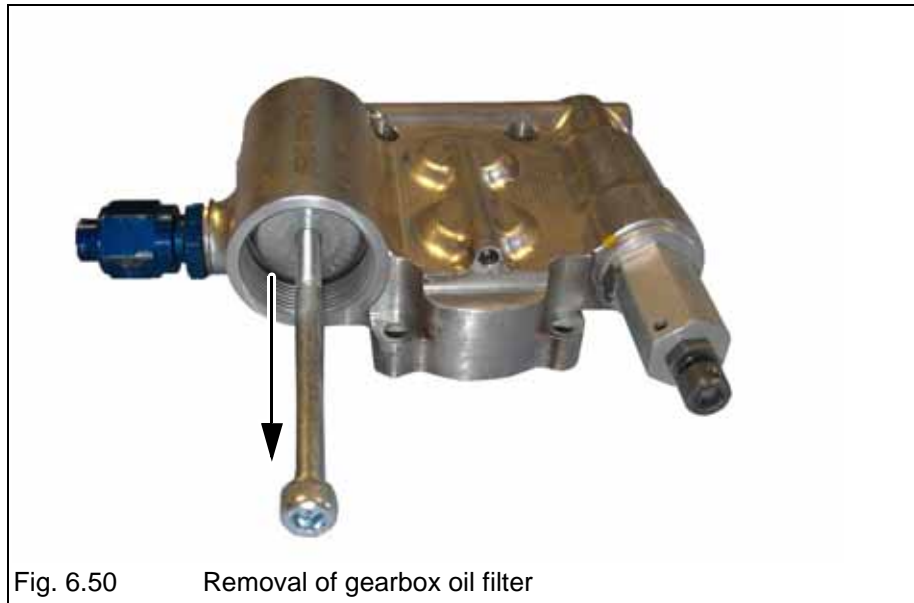

7. Insert the new gearbox oil filter. For mounting direction see Fig. 6.51 and Fig. 6.52.

■ CAUTION: Only use an original Technify Motors GmbH gearbox oil filter.

◆ Note: Make sure that the new o-ring is correctly mounted to the new oil-filter. The o-ring is part of the new oil filter (Fig. 6.51, item a).

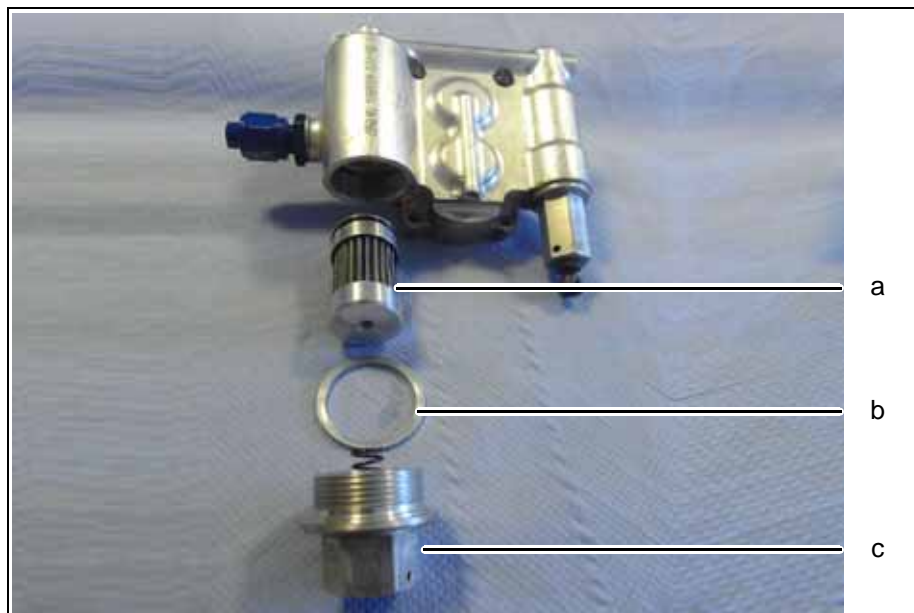

Fig. 6.51 Gearbox oil filter assembling

- a Filter element with o-ring
- b Sealing ring (aluminum)
- c Filter cap with spring



Fig. 6.52 Mounting direction of the oil filter

8. Attach the new aluminum sealing ring to the filter cap (see Fig. 6.51, item b).

◆ **Note:** Make sure that the spring in the filter cap is fixed.

9. Remount the filter cap and tighten it to the specified tightening torque.
Tightening Torque:
30 Nm
10. Loosen the oil filler screw and remove it. (Fig. 6.49, item a).
11. Fill in 1 liter new gearbox oil.

■ **CAUTION:** Do not overfill the gearbox!

■ **CAUTION:** Use only gearbox oil which is specified in Chapter 3, Section 3.5, Page 3 of this Manual.

◆ **Note:** Before refilling, shake the gearbox oil bottle, in order to mix the gearbox oil and the additives.

12. Remount the oil filler screw with a new sealing ring and tighten it to the specified tightening torque.
Tightening Torque:
35 Nm
13. Preset the proportional pressure reducing valve. Refer to Chapter 72-10.05 of RM-02-02.

14. Secure the gearbox oil filter cap with a locking wire. See Fig. 6.53.



Fig. 6.53 Lock wire between oil filter cap, proportional pressure reducing valve and the gearbox housing

15. Secure the oil drain plug with a lock wire. See Fig. 6.54.



Fig. 6.54 Lock wiring the oil drain screw

16. Secure the oil filler screw with a lock wire. See Fig. 6.55.



Fig. 6.55 Lock wiring the oil filler screw

17. Do an Engine Test run according to Annex 4 of this Chapter.
18. Do a visual inspection and a check for leaks.
19. Check the gearbox oil level according to Annex 9 of this Chapter

Annex 14 Exchanging the Coolant

▲ **WARNING:** Risk of scalding! The cooling system may be pressurized. Carefully release the pressure before opening the drain plug.

■ **CAUTION:** Do not drain the coolant if its temperature is above 40°C.

1. Draining the coolant:

- Open the clamp on the lower hose of the water radiator, disconnect the hose and allow the coolant to drain into a prepared collecting container.
- Open the clamp on the lower hose of the heat exchanger, disconnect the hose and allow the coolant to drain into a collection container.
- Open the drain plug. Allow the coolant to drain into a collection container.
- After draining reinstall and tighten the drain plug.
Tightening Torque:
30 Nm
- Reconnect the lower hoses of the water radiator and the heat exchanger. Tighten the clamps.

2. Filling up new coolant:

- Fill up the cooling system with coolant according to IM-02-02 Chapter 4 by opening the coolant filler.
- Close the cover of the coolant filler.
- Perform a test run according to Chapter 4, Section 4.4.2, Page 5 of this Manual.
- Check the cooling system for leaks according to Annex 3 of this Chapter.
- Allow the engine to cool down.
- Check coolant level.

Annex 15 Inspecting the Gearbox

The gearbox must be delivered to Technify Motors GmbH for inspection.

To remove and install the gearbox, refer to RM-02-02.

Annex 16 Replacing the Excitation Battery

■ **CAUTION:** Never connect a voltage to the alternator when the lines to the excitation battery are not connected. The line to the excitation battery carries a voltage from the alternator and must therefore not come into contact with a ground connection or similar.

◆ **Note:** The place where the excitation battery is installed depends on the aircraft installation.

28V-Version

1. Disconnect the excitation batteries (b).
2. Remove the upper excitation battery holder (a). To do this, undo the two screws (c).

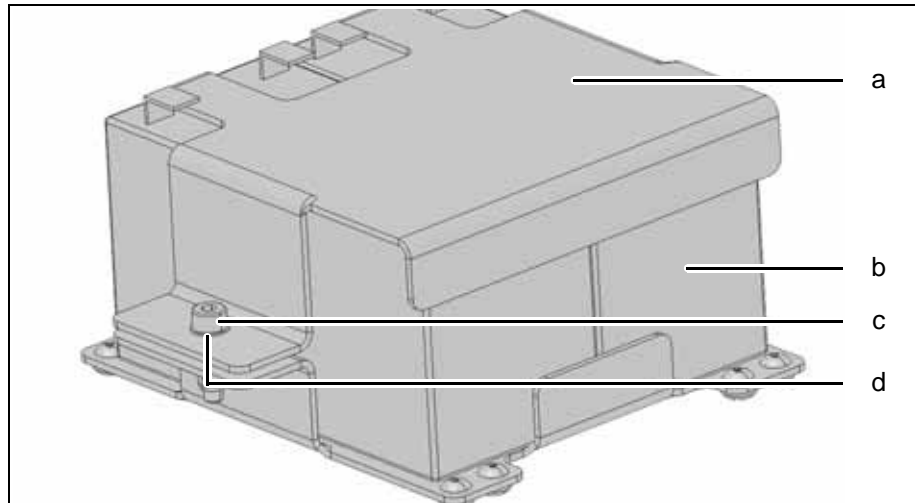

Fig. 6.56 Excitation battery holder (28V)

- a Upper excitation battery holder, P/N: 20-3940-H0023xx
- b Excitation battery, P/N: 20-3940-H002101
- c Screw, excitation battery holder, P/N: NM-0000-00209xx
- d Washer, P/N: NM-0000-00150xx

3. Replace the excitation batteries (b).
4. Fit the upper excitation battery holder to the lower excitation battery holder using two screws (c) and two washers (d).

Tightening torque:

3.5 Nm

5. Connect the wiring harness to the excitation batteries. The blue cable lug is pushed onto the black connection (-) of the first excitation battery. The short connection line connects both excitation batteries (series connection). The red cable lug is pushed onto the red connection (+) of the second excitation battery. Afterwards, connect the wiring harness to the wiring harness of the alternator regulator ("Exc. Batt" plug connection).

14V-Version

1. Disconnect the excitation battery.
2. Remove the excitation battery holder (a). To do this, undo the four screws (c). See Fig. 6.57.

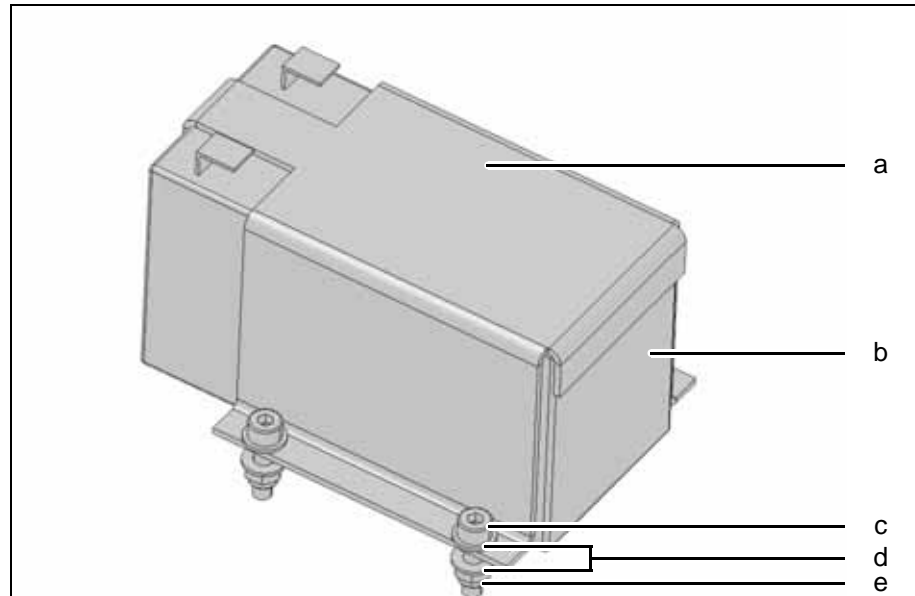

Fig. 6.57 Excitation battery holder (14V)

- a Excitation battery holder, P/N: 20-3940-55165xx
- b Excitation battery, P/N: 20-3940-H0021xx
- c Screw, excitation battery holder, P/N: NM-0000-00209xx
- d Washer, P/N: NM-0000-00150xx
- e Stop nut, P/N: NM-0000-00179xx

3. Replace the excitation battery (b).
4. Refit the excitation battery holder with the new excitation battery using four screws (c), eight washers (d) and four stop nuts (e).

Tightening torque:

3.5 Nm

5. Connect the wiring harness to the excitation battery. The blue cable lug is pushed onto the black connection (-) of the excitation battery. The red cable lug is pushed onto the red connection (+) of the excitation battery.
6. Perform an Engine Test Run, refer to Annex 4 of this Chapter.

Annex 17 FADEC Software Update

Hardware Requirements

This software has been designed for Microsoft Windows 2000/XP/Vista. For proper functionality, the Microsoft .Net framework version 3.5 or newer is required (Windows Vista already contains this). If you don't have a proper .NET version installed, please download the framework at www.microsoft.com/net.

◆ **Note:** Administrative privileges are required during the installation of the software.

Installation and De-installation

1. Please start installation of the software by double-clicking the setup file that you have received.
2. Follow the instructions given to you during the process. Afterwards, you can start the program by using the link on your computer's desktop.

◆ **Note:** In order to uninstall the FADEC Updater, please use the uninstall option found under Add/Remove Software or execute the uninstaller in the installation directory.

Update Process

1. For updating FADEC software, please attach the USB CAN interface to the FADEC and your computer.
2. Battery switch - „**ON**“
3. Engine master switch - „**ON**“

■ **CAUTION:** Do NOT start the engine!

4. Start the Technify FADEC Updater program.

■ **CAUTION:** Make sure that no other program is running or accessing the FADEC during update.

5. Press "Start Update" to continue to the current information screen. The attached FADEC will be scanned for current firmware and mapping information. See Fig. 6.58.

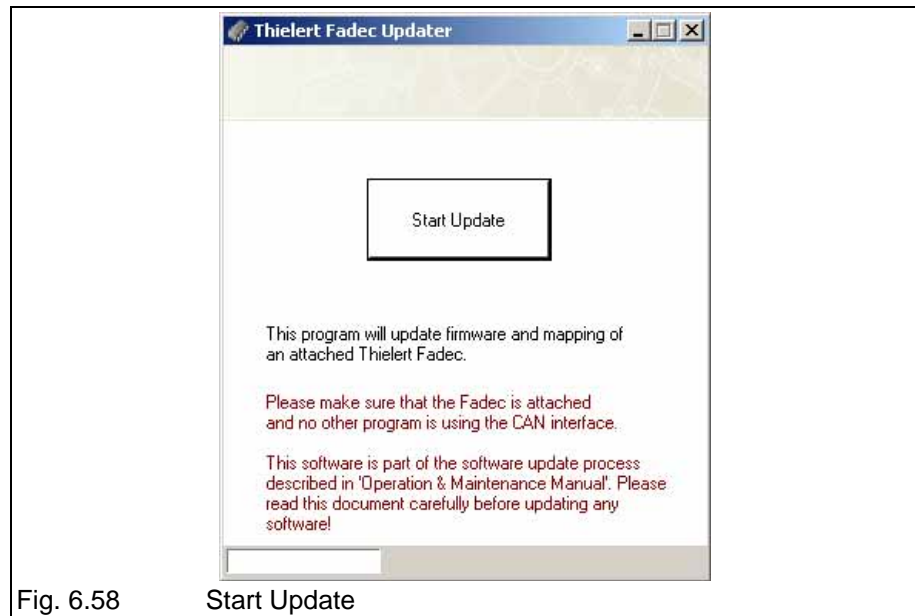

Fig. 6.58 Start Update

6. Current firmware, mapping and serial number of the FADEC as well as information about the aircraft type is displayed. Also, for each FADEC an update status is displayed. See Fig. 6.59.

■ **CAUTION:** Check all information for correctness. If there are doubts about the correctness of the information or if there are any questions about the update process, please contact Technify Motors GmbH before proceeding.



Fig. 6.59 Information displayed

7. If all information is correct, proceed to the next step by pressing "Update".

8. The current update status is displayed in the lower left corner. See Fig. 6.60.

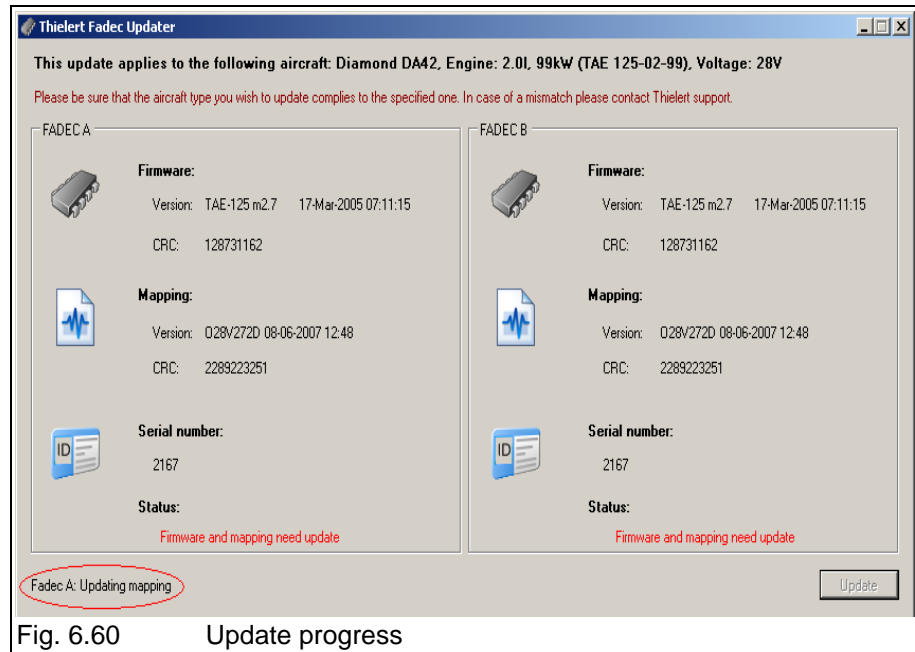

9. After a successful update, the following message will appear. Please press "OK" to proceed to the next step. See Fig. 6.61.

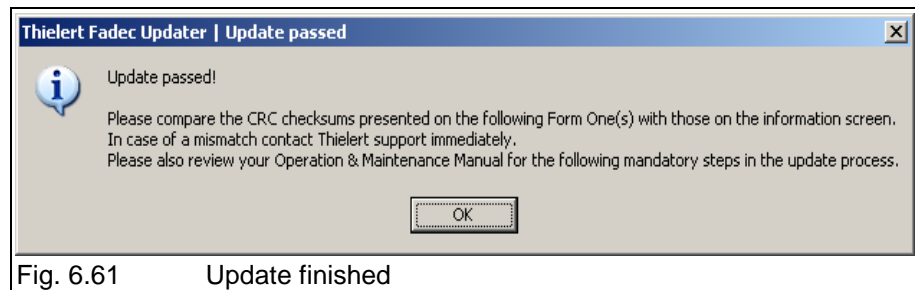

10. You will be presented the EASA Form 1. Please compare the CRC checksum on the EASA Form 1 (see Fig. 6.63) with the checksum on the information screen (see Fig. 6.64).

■ **Note:** In case the update fails please check your CAN connection and power supply for the FADEC. You can then restart the application and go back to step 5. The Updater will recognize the previously failed update and ask you what to do. As long as you are connected to the **same** FADEC as before you can retry the update by clicking on 'Yes' (see Fig. 6.62). If you are connected to another FADEC please select 'No'.

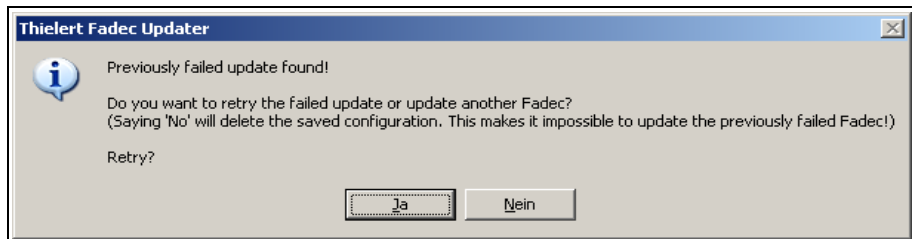

Fig. 6.62 Previously failed update

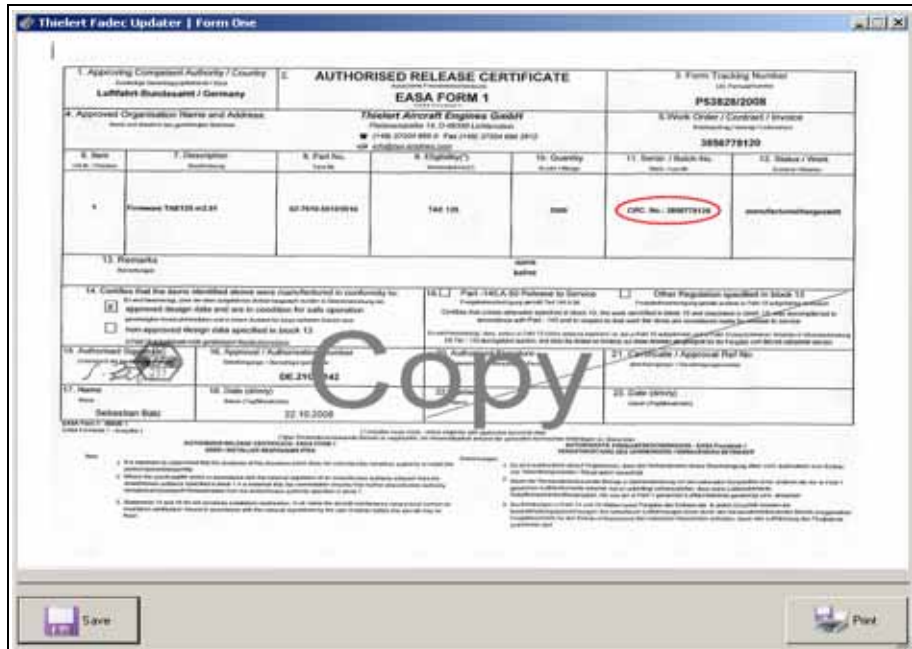

Fig. 6.63 Form One

11. Please save the Form 1.

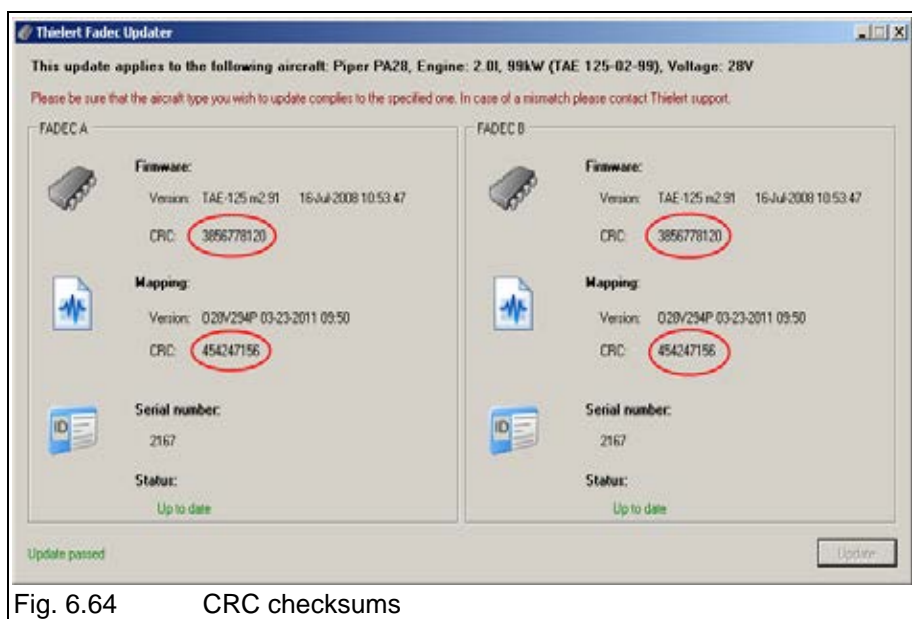

Fig. 6.64 CRC checksums

12. If both firmware and mapping have been updated, a second Form 1 will be presented when closing the first one (see step 11).
13. After comparing the checksums you may close the FADEC Updater.
14. Perform a „Diagnostic Reset“. Refer to Section 7 „Clearing Diagnostic Warnings“ in Annex 10 of this Chapter.
15. Start the FADEC Service Tool.
16. Compare the CRC checksums with those found on the Form 1(s) (see Fig. 6.63 and Fig. 6.64).

■ **CAUTION:** The CRC checksums presented by the FADEC Service Tool need to match exactly with those on the Form 1(s). In case of a mismatch contact Technify Motors GmbH immediately!

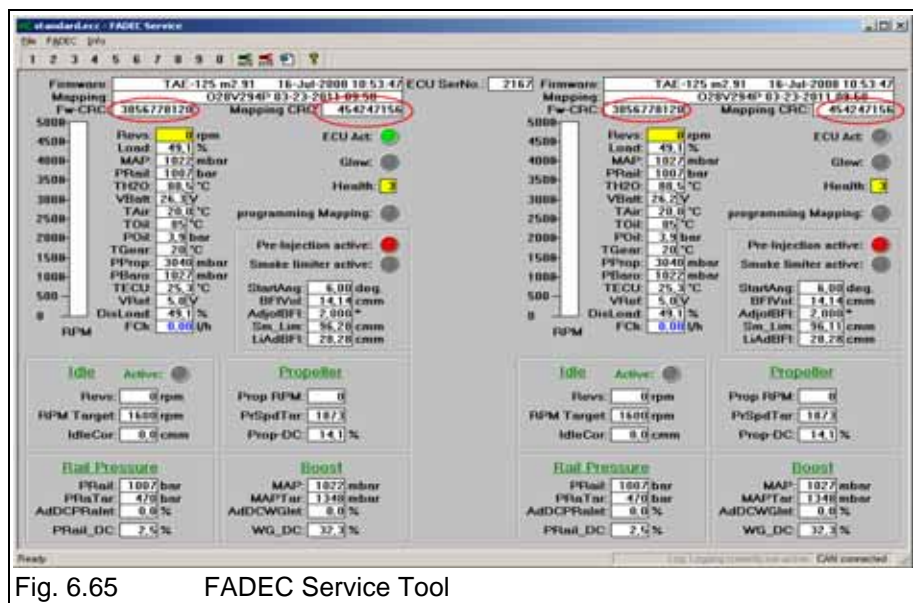

Fig. 6.65 FADEC Service Tool

17. Disconnect the USB CAN interface from the FADEC and your computer.
18. Engine master switch - „OFF“
19. Battery master switch - „OFF“

Annex 18 Inspecting the Fuel Feed Pump

The fuel feed pump must be delivered to Technify Motors GmbH for inspection.

To remove and install the fuel feed pump, refer to RM-02-02.

7 Emergency Procedures

■ **CAUTION:** If the FADEC has been operated by the battery only, a temporary decrease of the rotational speed is possible by switching on the Alternator. In any case leave the Alternator switched on.

◆ **Note:** The following steps must be taken in the event of power loss or engine failure!

7.1 Power Loss

In the event of power loss, move the load selector fully forward (takeoff power position) and select a fuel tank with sufficient fuel level.

7.2 FADEC Operation

The FADEC system consists of two identical and independent FADEC-halves, which continually monitor each others status.

In normal operation, the manual Force B switch should be switched to the "A" position. This means that FADEC A (Engine Control Unit A) is actively controlling the engine, and FADEC B is in stand-by mode. If the FADEC system detects a problem with channel A, the FADEC A light begins to flash and the system automatically switches over to FADEC B. If the FADEC system detects a problem with channel B, the FADEC B light begins to flash, and the system automatically switches to whichever channel is the healthiest.

If the Force B switch is in the "B" position, only FADEC B will be allowed to actively control the engine. In this position, the FADEC system cannot switch automatically between channel A and B. This position is necessary only if the FADEC system does not switch automatically to the healthiest channel in the event of abnormal engine behavior.

▲ **WARNING:** It is strongly recommended to always operate with the Force B switch in the "A" position, as this will allow the FADEC system to choose automatically the healthiest channel.

7.3 Engine System Malfunction

- ◆ Note: The FADEC consists of two components that are independent of each other: FADEC A and FADEC B. In case of malfunctions in the active FADEC, it automatically switches to the other.

7.3.1 One FADEC light flashing

1. Press FADEC test button at least 2 seconds (refer to Chapter 4, Section 4.4.3, Page 7 of this Manual)
2. FADEC lights extinguished (temporary failure):
 - a) Continue flight normally
 - b) Inform service center after landing. The lights will illuminate after the ignition has been switched off and on.
3. FADEC lights steady illuminated (steady failure or high category failure):
 - a) Observe the other FADEC lamp
 - b) Fly to the next airfield or landing strip
 - c) Select an airspeed according to the appropriate POH
 - d) Inform service center after landing

7.3.2 Both FADEC lights flashing

◆ **Note:** The Load Display may not correspond to the current value.

1. Press FADEC-Testbutton at least 2 seconds (refer to Chapter 4, Section 4.4.3, Page 7 of this Manual)
2. FADEC lights extinguished (temporary failure):
 - a) Continue flight normally
 - b) Inform service center after landing. The lights will illuminate after the ignition has been switched off and on.
3. FADEC lights steady illuminated (steady failure or high category failure):
 - a) Check the available engine power
 - b) Expect engine failure
 - c) Flight can be continued, however the pilot should
 - select an airspeed according to the appropriate POH
 - fly to the next airfield or landing strip
 - be prepared for an emergency landing
 - d) Inform service center after landing

7.3.3 Abnormal engine behavior

If abnormal engine behavior should occur during flight and the FADEC does not automatically switch over to FADEC B, it is possible to switch over to FADEC B manually using the "Force B" switch. However, this switch position prevents the auto-monitoring between the two FADEC halves.

▲ **WARNING:** It is strongly recommended to always operate with the Force B switch in the automatic position, as this will allow the FADEC system to choose automatically the healthiest FADEC.

Before attempting to restart the engine when on the ground, check the plug and socket connections according to Chapter 6, Annex 7, Page 18 of this Manual and carry out the "Pre-Flight Check" as described in Chapter 6, Section 6.1, Page 2 of this Manual.

7.4 Restart after Engine Failure

Whilst gliding to a suitable landing strip, try to determine the reason for the engine malfunction. If time permits and a restart of the engine is possible, proceed as follows:

1. Air speed according to the Pilot's Operating Handbook
2. Glide below 13000 ft
3. Fuel selector to a tank with sufficient fuel quantity
4. Electric fuel pump (if installed) - "**ON**"
5. Load Selector - "**IDLE**"
6. Engine Master "**OFF**", then "**ON**" (if the propeller does not turn, then additionally Starter "**ON**")*
7. Check the engine power: Load Selector 100%, engine parameters, check altitude and airspeed

* The propeller will normally continue to turn as long as the airspeed is above 65 KIAS. Should the propeller stop an airspeed of 65 KIAS or more, the reason for this should be found out before attempting a restart. It is obvious that the engine or propeller is jammed, do not use the Starter.

◆ **Note:** If the Engine Master ("IGN" resp.) is in position OFF, the Load Display shows 0% even if the propeller is turning.

7.5 Fire in the Engine Compartment

1. Fuel shut-off valve - "**CLOSED**"
2. Engine master switch - "**OFF**"
3. Electric fuel pump (if installed) - "**OFF**"

▲ **WARNING:** If this action does not extinguish the fire, a safety or emergency landing must be initiated. Related data in the Pilot's Operating Handbook must be taken into account.

7.6 Air in the Fuel System (During Flight)

1. Move the fuel tank selector to a tank with sufficient fuel
2. Electric fuel pump (if installed) - "ON"
3. Engage the starter

▲ **WARNING:** If there is air in the fuel system, the engine stalls within a few seconds. It takes about 15 seconds before the engine restarts.

▲ **WARNING:** The high-pressure pump has to be inspected before the next flight.

7.7 Oil Pressure too Low (During Flight)

1. Reduce power as quickly as possible
2. Monitor the oil pressure:
 - a) If the oil pressure rises into the green, continue flight with a power setting which keeps the oil pressure in the green, if possible.
 - b) If the oil pressure remains too low, expect engine failure and prepare for an emergency landing.

◆ **Note:** If the engine fails due to low oil pressure, the propeller will also stop turning. The glide ratio of an aircraft with a stopped propeller is higher than with windmilling, so that the range for an emergency landing increases. Related data in the Pilot's Operating Handbook must be taken into account.

This page intentionally left blank

Change of Hands



Technify Motors GmbH
 Platanenstraße 14
 D-09356 St. Egidien
 GERMANY

Dear Engine Owner,

To enable a smooth supply of instructions for continued airworthiness, we kindly request you to fill out this form, when you sell your engine or aircraft.
 Please send this form by e-mail, fax or post to Technify Motors GmbH.

| | | | |
|---|--------------|---|----------------|
| A | Vendor | Name: | |
| | | Adress: | |
| | | Tel.: | |
| | | E-Mail: | |
| B | Buyer | Name: | |
| | | Adress: | |
| | | Tel.: | |
| | | E-Mail: | |
| C | Engine | Type Designation: | Serial number: |
| | | | |
| D | Aircraft | Manufacturer: | Type: |
| | | Registration / state of operation: | |
| E | Confirmation | _____ Date Sign | |

Inspection of the timing chain



Technify Motors GmbH
 Platanenstraße 14
 D-09356 St. Egidien
 GERMANY

Dear Engine Owner,

To enable a continuously improvement of our product, we kindly request you to fill out this form, when you perform an inspection of the timing chain (according RM-02-02 Chapter 05-20.04). Please send this form preferentially by e-mail, also possible by fax or post to Technify Motors GmbH.

| | | | |
|---|--------------|------------------------------------|--------------------------|
| A | Owner | Name: | |
| | | Adress: | |
| | | Tel.: | |
| | | E-Mail: | |
| B | Aircraft | Manufacturer: | Type: |
| | | Registration / state of operation: | |
| C | Engine | Type Designation: | Serial number: |
| | | Engine runtime: | |
| D | Timing Chain | Timing Chain runtime: | Measuring values: / / |
| E | Confirmation | _____ Date of Inspection Sign | |

Engine Maintenance Checklist - After the 3rd - 6th operating hour

1. General

Enter the applicable data in the blocks below:

| | | |
|-----------------|---|------------------|
| Engine | Type Designation: | Serial number: |
| | Hours, TTSN/STSO: | |
| Aircraft | Manufacturer: | Type: |
| | Registration: | Operating Hours: |
| Check | Engine Maintenance Check - After the 3rd - 6th operating hour | Date: |

2. Engine Maintenance Checklist

| Inspection Items | Initials |
|--|----------|
| Check the oil system for leakage (refer to Chapter 6, Annex 2 of this Manual) | |
| Check the fuel system for leakage (refer to Chapter 6, Annex 2 of this Manual) | |
| Check the cooling system for leakage (refer to Chapter 6, Annex 3 of this Manual) | |
| Visually inspect the air filter | |
| Visually inspect hoses and fuel pipes | |
| Visually inspect the FADEC sensors (refer to Chapter 6, Annex 7 of this Manual) | |
| Visually inspect the exhaust system | |
| Visual inspection of the v-ribbed belt (refer to Chapter 6, Annex 1 of this Manual) | |

| | |
|---|---|
| Engine Maintenance Checklist - After the 3rd - 6th operating hour Revision no.: - Revision date: - | Chapter: Checklist Issue: 4 Issue date: 17.04.2015 Page: 1 Content: 2 |
|---|---|



Operation & Maintenance Manual

CD-135 / CD-155

OM-02-02

| Inspection Items | Initials |
|---|----------|
| <p>Perform an engine test run</p> <p>according to Chapter 4, Section 4.4.2, Page 5 of this Manual, read out the FADEC. E-mail both the Real Time Log Files and Event Log Files to Technify Motors GmbH (refer to Chapter 6, Annex 10 of this Manual)</p> | |
| <p>Exchange the gearbox oil filter (refer to Chapter 6, Annex 8 of this Manual)</p> <p>The used gearbox oil filter should be labeled, stored in a clean container and made available to Technify Motors GmbH on request for the complete engine life time. The sample will be required for a later long-run analysis. The label must show the aircraft serial number, registration number, engine serial number, operation time and date.</p> | |
| <p>Check the presetting of the proportional pressure reducing valve (refer to RM-02-02, Chapter 72-10.05 or Chapter 72-10.16).</p> | |

FINAL INSPECTOR

in block letters

date, signature

| | | |
|-------------|------------|--|
| Chapter: | Checklist | Engine Maintenance Checklist - After the 3rd - 6th operating hour |
| Issue: | 4 | |
| Issue date: | 17.04.2015 | |
| Page: | 2 | Revision no.: - |
| Content: | 2 | Revision date: - |

Operation & Maintenance Manual
CD-135 / CD-155
OM-02-02



Engine Maintenance Checklist
- General

1. General

Enter the applicable data in the blocks below:

| | | |
|-----------------|--|------------------|
| Engine | Type Designation: | Serial number: |
| | Hours, TTSN/STSO: | |
| Aircraft | Manufacturer: | Type: |
| | Registration: | Operating Hours: |
| Check | (100, 200, 300, 400hr..., Annual Inspection) | Date: |

2. Engine Maintenance Checklist

◆ **Note:** Signing with your initials carried out checks and strike out not carried out checks of the checklist.

| Inspection Items | Interval (Engine operation hours) | | | | | | | | | Time | Initials |
|--|--------------------------------------|-----|-----|-----|-----|------|------|------|--|-------------------|----------|
| | 100 | 200 | 300 | 600 | 900 | 1200 | 1500 | 1800 | | | |
| Protect engine against corrosion. Start-up the engine for at least 20 minutes (refer to Chapter 4, Section 4.2, Page 2 of this Manual) | | | | | | | | | | every month | |
| Visual inspection of all fuel, oil, cooling system lines and hoses for chafe marks (refer to RM-02-02 Chapter 05-20.03) | x | x | x | x | x | x | x | x | | | |
| Replace all fuel, oil and cooling system lines (refer to RM-02-02 Chapter 05-20.03) Flexible hose / hose assemblies replacement times are in-service times. In-service times must be determined by 1. the date the aircraft was licensed, if new or 2. the date entered in the logbook for the replacement hose placed in service. Do not use the date stamped on the hose / hose assembly, as time may be included for shelf life, and not in-service use. | | | | | | | | | | every 60 month | |

| | |
|---|---|
| Engine Maintenance Checklist - General Revision no.: 5 Revision date: 20.07.2016 | Chapter: Checklist Issue: 4 Issue date: 17.04.2015 Page: 1 Content: 8 |
|---|---|



Operation & Maintenance Manual

CD-135 / CD-155

OM-02-02

| Inspection Items | Interval (Engine operation hours) | | | | | | | | Time | Initials |
|--|--------------------------------------|-----|-----|-----|-----|------|------|------|-------------------|----------|
| | 100 | 200 | 300 | 600 | 900 | 1200 | 1500 | 1800 | | |
| Visual inspection of the engine mount for chafe marks | x | x | x | x | x | x | x | x | | |
| Visually inspect the air filter | x | x | x | x | x | x | x | x | | |
| Visual inspection of the cooling system | x | x | x | x | x | x | x | x | | |
| Check the mixture ratio of the coolant | x | x | x | x | x | x | x | x | | |
| Exchange coolant (refer to the aircraft manufacturer's specifications) | | | | | | x | | | every 24 month | |
| Test the cooling system under pressure at 2.0 bar Duration: 2 minutes. Max. 2.0 bar must not be exceeded! Afterwards check for leakage (refer to the aircraft manufacturer's specifications). | x | x | x | x | x | x | x | x | | |
| Visual inspection of the oil system (refer to Chapter 6, Annex 2 of this Manual) | x | x | x | x | x | x | x | x | | |
| Visual inspection of the fuel system (refer to Chapter 6, Annex 2 of this Manual) | x | x | x | x | x | x | x | x | | |
| Replace the fuel filter (refer to the aircraft manufacturer's specifications) | x | x | x | x | x | x | x | x | | |
| Visual inspection of the FADEC sensors (refer to Chapter 6, Annex 7 of this Manual) | x | x | x | x | x | x | x | x | | |
| Visual inspection of the exhaust system | x | x | x | x | x | x | x | x | | |
| Visual inspection of the clamp on the turbocharger | x | x | x | x | x | x | x | x | | |
| Visual inspection of the gasket of the turbocharger oil return line, replace if necessary. | | | | | | x | | | only CD-135 | |
| Visual inspection of the v-ribbed belt (refer to Chapter 6, Annex 6 of this Manual) | x | x | x | x | x | x | x | x | | |
| Replace v-ribbed belt (refer to RM-02-02, Chapter 72-20.01) | | | | | | x | | | | |
| Check the airframe fuel pump (refer to the aircraft manufacturer's specifications) | x | x | x | x | x | x | x | x | | |

Operation & Maintenance Manual

CD-135 / CD-155

OM-02-02



| Inspection Items | Interval (Engine operation hours) | | | | | | | | Time | Initials |
|--|--------------------------------------|-----|-----|-----|-----|------|------|------|----------------|----------|
| | 100 | 200 | 300 | 600 | 900 | 1200 | 1500 | 1800 | | |
| <p>Perform an engine test run according to Chapter 4, Section 4.4.2, Page 5 of this Manual and read out the FADEC. E-mail both the Real Time Log Files and Event Log Files to Technify Motors GmbH (refer to Chapter 6, Annex 10 of this Manual).</p> | x | x | x | x | x | x | x | x | | |
| <p>Exchange the engine oil and the oil filter (refer to Chapter 6, Annex 5 of this Manual);</p> <p>A sample of the oil and the used oil filter should be labeled, stored in a clean container and made available to Technify Motors GmbH on request for the complete engine life time. The sample will be required for a later long-run analysis. The label must show the aircraft serial number, registration number, engine serial number, operation time and date.</p> <p>Quantity of oil to be taken for sample: 100ml</p> | x | x | x | x | x | x | x | x | every 12 month | |
| <p>Exchange gearbox oil and the gearbox oil filter (refer to Chapter 6, Annex 13 of this Manual);</p> <p>A sample of the oil and the used gearbox oil filter should be labeled, stored in a clean container and made available to Technify Motors GmbH on request for the complete engine life time. The sample will be required for later long-run analysis. The label must show the aircraft serial number, registration number, engine serial number, operation time and date.</p> <p>Quantity of oil to be taken for sample: 100ml</p> | x | x | x | x | x | x | x | x | every 12 month | |
| <p>Check the presetting of the proportional pressure reducing valve (refer to RM-02-02, Chapter 72-10.05 or Chapter 72-10.16)</p> | x | x | x | x | x | x | x | x | | |
| <p>Replace air filter</p> <p>When replacing the air filter check carefully that no foreign objects are in it.</p> | | x | | x | | x | | x | | |
| <p>Inspect fuel feed pump, except 05-7312-K0073xx, 05-7312-K0133xx (refer to Chapter 6, Annex 18 of this Manual)</p> | | | x | x | x | x | x | x | | |
| <p>Inspect fuel feed pump 05-7312-K0073xx, 05-7312-K0133xx (refer to Chapter 6, Annex 18 of this Manual)</p> | | | | x | | x | | x | | |
| <p>Replace high-pressure pump (refer to Chapter 6, Annex 11 of this Manual)</p> <p>Replacement of the high-pressure pump at every 300 operating hours is only applicable if TS-1 jet fuel is being used.</p> | | | x | x | x | x | x | x | | |

Engine Maintenance Checklist - General

Revision no.: 5
Revision date: 20.07.2016

Chapter: Checklist
Issue: 4
Issue date: 17.04.2015
Page: 3
Content: 8



Operation & Maintenance Manual

CD-135 / CD-155

OM-02-02

| Inspection Items | Interval (Engine operation hours) | | | | | | | | Time | Initials |
|--|--------------------------------------|-----|-----|-----|-----|------|------|------|-------------------|----------|
| | 100 | 200 | 300 | 600 | 900 | 1200 | 1500 | 1800 | | |
| Replace high-pressure pump (refer to Chapter 6, Annex 11 of this Manual) If TS-1 jet fuel is being used, the high-pressure pump MUST be replaced every 300 operating hours. | | | | x | | x | | x | | |
| Replace excitation battery of the alternator (refer to Chapter 6, Annex 16 of this Manual) | | | | | | | | | every 12 month | |
| Replace alternator 14V / 28V (refer to Chapter 6, Annex 12 of this Manual) | | | | x | | x | | x | | |
| Replace rail pressure control valve (refer to RM-02-02, Chapter 73-10.07) | | | | x | | x | | x | | |
| Replace proportional pressure reducing valve (part of the gearbox) | | | | | | x | | | | |
| Replace clutch, if clutch assy 05-7211-K006001 or 05-7211-K006002 is installed (refer to RM-02-02, Chapter 72-10.02) | | | x | x | x | x | x | x | | |
| Replace friction disk, if clutch assy 05-7211-K0094xx is installed (refer to RM-02-02, Chapter 72-10.14) | | | | | x | | | x | | |
| Inspect dual mass flywheel (refer to RM-02-02, Chapter 05-20.02) | | | | x | | x | | x | | |

Operation & Maintenance Manual

CD-135 / CD-155

OM-02-02



| Inspection Items | Interval (Engine operation hours) | | | | | | | | Time | Initials |
|---|--------------------------------------|-----|-----|-----|-----|------|------|------|-------------|----------|
| | 100 | 200 | 300 | 600 | 900 | 1200 | 1500 | 1800 | | |
| Inspect gearbox (refer to Chapter 6, Annex 15 of this Manual) | | | x | x | x | x | x | x | | |
| Inspect gearbox (refer to Chapter 6, Annex 15 of this Manual) | | | | x | | x | | x | | |
| <p>The 1200 hrs gearbox inspection interval is only valid for P/N:</p> <p>05-7212-K0435 02 CD-135 14V 05-7212-K0436 02 CD-135 28V 05-7212-K0437 02 CD-155 14V 05-7212-K0438 02 CD-155 28V 05-7212-K0439 02 CD-135 28V DA42 05-7212-K0440 02 CD-155 28V DA42 05-7212-K0413 03 CD-135 14V 05-7212-K0414 03 CD-135 28V 05-7212-K0415 03 CD-155 14V 05-7212-K0416 03 CD-155 28V 05-7212-K0417 03 CD-135 28V DA42 05-7212-K0418 03 CD-155 28V DA42</p> <p>or later approved revisions, in combination with the dual mass flywheel and the use of gearbox oil Shell Spirax S6 ATF ZM or CENTURION Gearbox Oil N1. In all other cases, the interval remains at 300 or 600 hrs.</p> <p>The 600 hrs gearbox inspection interval is only valid in combination with the dual mass flywheel and with the use of gearbox oil Shell Spirax S6 ATF ZM or CENTURION Gearbox Oil N1. In all other cases, the interval remains at 300 hrs.</p> | | | | | | | | | | |
| Inspect AltReg loom (refer to RM-02-02, Chapter 05-20.01) | | | | x | | x | | x | | |
| Replace timing chain ONLY applicable for engines Version 01 (refer to RM-02-02, Chapter 72-30.02) | | | | | x | | | | | |
| Inspect timing chain ONLY applicable for engines Version 02 (refer to RM-02-02, Chapter 05-20.04) | | | | | | x | x | x | | |
| Replace coolant hose 05-7523-K0048xx (only DA42 installations) | | | | | | x | | | only CD-135 | |
| Replace engine shock mounts (refer to RM-02-02, Chapter 71-20.01; 71-20.02; 71-20.03) | | | | | | x | | | only CD-155 | |
| Replace engine shock mounts (refer to RM-02-02, Chapter 71-20.01; 71-20.02; 71-20.03) | | | | | | | x | | only CD-135 | |

Engine Maintenance Checklist - General

Revision no.: 5
 Revision date: 20.07.2016

Chapter: Checklist
 Issue: 4
 Issue date: 17.04.2015
 Page: 5
 Content: 8



Operation & Maintenance Manual

CD-135 / CD-155

OM-02-02

| Inspection Items | Interval (Engine operation hours) | | | | | | | | Time | Initials |
|---|--------------------------------------|-----|-----|-----|-----|------|------|------|-------------------|----------|
| | 100 | 200 | 300 | 600 | 900 | 1200 | 1500 | 1800 | | |
| FADEC maintenance (to be carried out by the engine manufacturer) | | | | | | | | | every 60 month | |

FINAL INSPECTOR

in block letters

date, signature

